



***Stock shapes***

*Engineering plastics –  
The Manual*

Ensinger 



*This manual is designed to provide readers with a compact outline of our extensive fund of plastics-related knowledge. Alongside a grounding of theoretical facts and information, the manual also provides a range of practical tips and material recommendations, together with calculation examples for component design and advice on the further processing of plastics.*

- 4 Overview of plastics
- 6 Classification of plastics
- 7 Ensinger process chain
- 8 Processing methods

### ***Materials***

- 12 TECARAN ABS
- 13 TECANYL
- 14 TECAFINE PE
- 15 TECAFINE PMP
- 16 TECAPRO MT / TECAFINE PP
- 18 TECAFORM
- 20 TECAMID
- 22 TECAST / TECARIM
- 24 TECADUR / TECAPET
- 26 TECANAT
- 28 TECAFLON
- 30 TECAPEI
- 32 TECASON S, P, E
- 34 TECATRON
- 36 TECAPEEK
- 38 TECATOR
- 40 TECASINT

### ***Properties***

- 44 Modifications / additives
- 46 Thermal properties
- 50 Mechanical properties
- 54 Processing influences
- 55 Tribological characteristics
- 57 Electrical properties
- 60 Chemical resistance
- 62 Moisture absorption
- 63 Flame retardant classification
- 64 Radiation resistance
- 66 Certifications and approvals

### ***Material selection and calculations***

- 70 Material selection
- 72 Calculations

### ***Further processing***

- 76 Processing plastics
  - 77 Machining guidelines
  - 78 Tempering
  - 80 Welding
  - 82 Gluing
  - 84 Cleaning plastics
  - 86 Product handling
  - 88 Material guideline values
- 98 Liability disclaimer

# Overview of plastics

## TECARAN ABS (ABS)

**Long-term service temperature**

**Glass transition temperature**

**Modulus of elasticity**

**Tensile strength**

**Modifications**

- Fibre-reinforced
- Modified sliding properties
- Electrically conductive
- Detectable
- Medical technology
- Food technology

**Stock shapes**

- 10 – 200 mm
- 5 – 100 mm

→ p. 12

## TECAPRO MT (PP)

**Long-term service temperature**

**Glass transition temperature**

**Modulus of elasticity**

**Tensile strength**

**Modifications**

- Fibre-reinforced
- Modified sliding properties
- Electrically conductive
- Detectable
- Medical technology
- Food technology

**Stock shapes**

- 10 – 200 mm
- 5 – 100 mm

→ p. 16

## TECAMID 11/12 (PA 11/12)

**Long-term service temperature**

**Glass transition temperature**

**Modulus of elasticity**

**Tensile strength**

**Modifications**

- Fibre-reinforced
- Modified sliding properties
- Electrically conductive
- Detectable
- Medical technology
- Food technology

**Stock shapes**

- 4 – 250 mm
- 5 – 100 mm
- 25 – 300 mm

→ p. 20

## TECARIM (PA 6 C)

**Long-term service temperature**

**Glass transition temperature**

**Modulus of elasticity**

**Tensile strength**

**Modifications**

- Fibre-reinforced
- Modified sliding properties
- Electrically conductive
- Detectable
- Medical technology
- Food technology

**Stock shapes**

- 50 – 800 mm
- 8 – 200 mm
- 50 – 600 mm

→ p. 22

## TECANYL (PPE)

**Long-term service temperature**

**Glass transition temperature**

**Modulus of elasticity**

**Tensile strength**

**Modifications**

- Fibre-reinforced
- Modified sliding properties
- Electrically conductive
- Detectable
- Medical technology
- Food technology

**Stock shapes**

- 10 – 200 mm
- 5 – 100 mm

→ p. 13

## TECAFORM AH (POM-C)

**Long-term service temperature**

**Glass transition temperature**

**Modulus of elasticity**

**Tensile strength**

**Modifications**

- Fibre-reinforced
- Modified sliding properties
- Electrically conductive
- Detectable
- Medical technology
- Food technology

**Stock shapes**

- 3 – 250 mm
- 5 – 150 mm
- 20 – 505 mm

→ p. 18

## TECAMID 6/66 (PA 6/66)

**Long-term service temperature**

**Glass transition temperature**

**Modulus of elasticity**

**Tensile strength**

**Modifications**

- Fibre-reinforced
- Modified sliding properties
- Electrically conductive
- Detectable
- Medical technology
- Food technology

**Stock shapes**

- 4 – 250 mm
- 5 – 100 mm
- 25 – 300 mm

→ p. 20

## TECAPET (PET)

**Long-term service temperature**

**Glass transition temperature**

**Modulus of elasticity**

**Tensile strength**

**Modifications**

- Fibre-reinforced
- Modified sliding properties
- Electrically conductive
- Detectable
- Medical technology
- Food technology

**Stock shapes**

- 10 – 180 mm
- 8 – 100 mm

→ p. 24

## TECAFINE PE (PE)

**Long-term service temperature**

**Glass transition temperature**

**Modulus of elasticity**

**Tensile strength**

**Modifications**

- Fibre-reinforced
- Modified sliding properties
- Electrically conductive
- Detectable
- Medical technology
- Food technology

**Stock shapes**

- 10 – 200 mm
- 5 – 100 mm

→ p. 14

## TECAFORM AD (POM-H)

**Long-term service temperature**

**Glass transition temperature**

**Modulus of elasticity**

**Tensile strength**

**Modifications**

- Fibre-reinforced
- Modified sliding properties
- Electrically conductive
- Detectable
- Medical technology
- Food technology

**Stock shapes**

- 3 – 250 mm
- 5 – 150 mm
- 20 – 505 mm

→ p. 18

## TECAST (PA 6 C)

**Long-term service temperature**

**Glass transition temperature**

**Modulus of elasticity**

**Tensile strength**

**Modifications**

- Fibre-reinforced
- Modified sliding properties
- Electrically conductive
- Detectable
- Medical technology
- Food technology

**Stock shapes**

- 50 – 800 mm
- 8 – 200 mm
- 50 – 600 mm

→ p. 22

## TECADUR PET (PET)

**Long-term service temperature**

**Glass transition temperature**

**Modulus of elasticity**

**Tensile strength**

**Modifications**

- Fibre-reinforced
- Modified sliding properties
- Electrically conductive
- Detectable
- Medical technology
- Food technology

**Stock shapes**

- 10 – 180 mm
- 8 – 100 mm

→ p. 24

### TECANAT (PC)



Long-term service temperature



Glass transition temperature



Modulus of elasticity



Tensile strength

#### Modifications

- Fibre-reinforced
- Modified sliding properties
- Electrically conductive
- Detectable
- Medical technology
- Food technology

#### Stock shapes

- 3 - 250 mm
- 10 - 100 mm

→ p. 26

### TECAPEI (PEI)



Long-term service temperature



Glass transition temperature



Modulus of elasticity



Tensile strength

#### Modifications

- Fibre-reinforced
- Modified sliding properties
- Electrically conductive
- Detectable
- Medical technology
- Food technology

#### Stock shapes

- 8 - 150 mm
- 10 - 80 mm

→ p. 30

### TECATRON (PPS)



Long-term service temperature



Glass transition temperature



Modulus of elasticity



Tensile strength

#### Modifications

- Fibre-reinforced
- Modified sliding properties
- Electrically conductive
- Detectable
- Medical technology
- Food technology

#### Stock shapes

- 10 - 60 mm
- 10 - 70 mm

→ p. 34

### TECATOR (PAI)



Long-term service temperature



Glass transition temperature



Modulus of elasticity



Tensile strength

#### Modifications

- Fibre-reinforced
- Modified sliding properties
- Electrically conductive
- Detectable
- Medical technology
- Food technology

#### Stock shapes

- 5 - 100 mm
- 5 - 30 mm

→ p. 38

### TECAFLON PTFE (PTFE)



Long-term service temperature



Glass transition temperature



Modulus of elasticity



Tensile strength

#### Modifications

- Fibre-reinforced
- Modified sliding properties
- Electrically conductive
- Detectable
- Medical technology
- Food technology

#### Stock shapes

- 4 - 300 mm
- 1 - 100 mm

→ p. 28

### TECASON S (PSU)



Long-term service temperature



Glass transition temperature



Modulus of elasticity



Tensile strength

#### Modifications

- Fibre-reinforced
- Modified sliding properties
- Electrically conductive
- Detectable
- Medical technology
- Food technology

#### Stock shapes

- 8 - 150 mm
- 10 - 80 mm

→ p. 32

### TECAPEEK (PEEK)



Long-term service temperature



Glass transition temperature



Modulus of elasticity



Tensile strength

#### Modifications

- Fibre-reinforced
- Modified sliding properties
- Electrically conductive
- Detectable
- Medical technology
- Food technology

#### Stock shapes

- 3 - 200 mm
- 5 - 100 mm
- 40 - 360 mm

→ p. 36

### TECASINT (PI)



Long-term service temperature



Glass transition temperature



Modulus of elasticity



Tensile strength

#### Modifications

- Fibre-reinforced
- Modified sliding properties
- Electrically conductive
- Detectable
- Medical technology
- Food technology

#### Stock shapes

- 6 - 100 mm
- 5 - 100 mm

→ p. 40

### TECAFLON PVDF (PVDF)



Long-term service temperature



Glass transition temperature



Modulus of elasticity



Tensile strength

#### Modifications

- Fibre-reinforced
- Modified sliding properties
- Electrically conductive
- Detectable
- Medical technology
- Food technology

#### Stock shapes

- 4 - 300 mm
- 10 - 100 mm

→ p. 28

### TECASON P (PPSU)



Long-term service temperature



Glass transition temperature



Modulus of elasticity



Tensile strength

#### Modifications

- Fibre-reinforced
- Modified sliding properties
- Electrically conductive
- Detectable
- Medical technology
- Food technology

#### Stock shapes

- 8 - 150 mm
- 10 - 80 mm

→ p. 32

# Classification of plastics

New polymer materials represent an important driving force for technological progress. Plastics have a whole array of benefits to offer and in many cases can effectively replace metals or ceramics. Among different types of polymers, a distinction is drawn between thermosetting plastics, elastomers and thermoplastics. Thermosetting polymers, or thermoset plastics, are plastics which permit no further deformation or shaping after three-dimensional chemical cross-linking. Elastomers are also cross linked materials but have the capacity for elastic deformation, and return to their original shape after exposure to load. Thermoplastic polymers, or thermoplastics, are reversibly re-meltable as they are not three-dimensionally cross-linked. The forces linking thermoplastic chains are less strong. The thermoplastic group of plastics is subdivided again into two different subgroups on the basis of their structure: amorphous and partially crystalline thermoplastics.

Ensinger processes thermoplastics. These can be deformed and reshaped repeatedly and offer very wide scope for modification.

On principle, the entire thermoplastic group is subdivided into three sections based partially on their thermal stability: standard, engineering and high-performance plastics. All of these groups are represented in the plastics pyramid diagram. As well as depicting the distinctions explained above, the pyramid also illustrates the relative manufactured quantities of the different product groups (in descending order to the tip of the pyramid).

Grading of plastics within the material classes

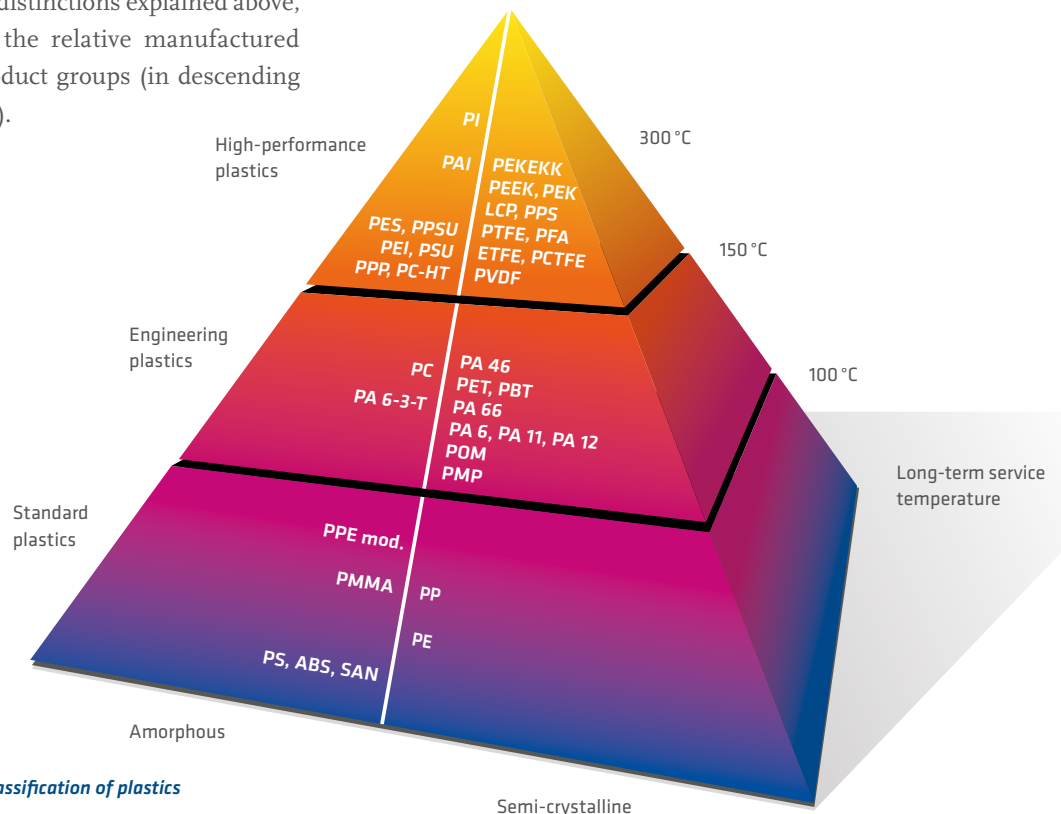
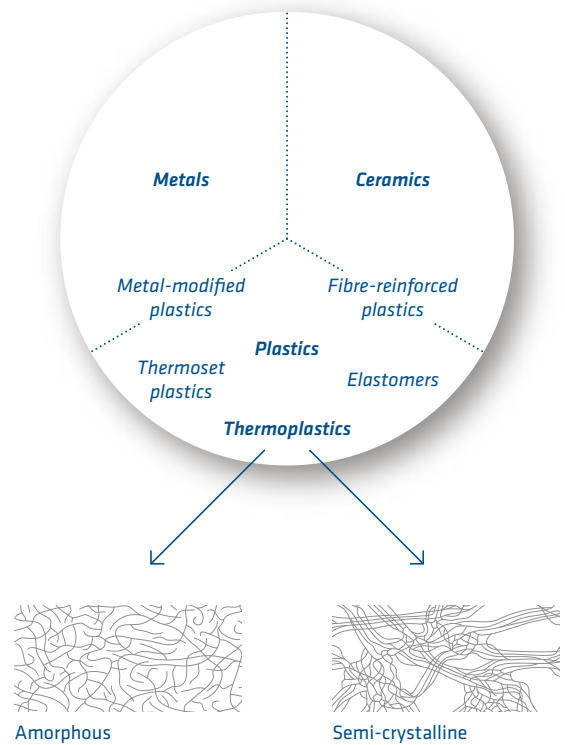

# Ensinger process chain

The name Ensinger brings together a broad-based range of production techniques for the processing of thermoplastics under a single roof. From the reactive cast polyamide method (custom casting) through compounding with a range of different additives, reworking to profiles and semi-finished products by extrusion and the injection moulding of finished parts, through to the machining of semi-finished and finished products, thermoplastic polymers are marketed in a wide range of processing stages.

It is often the material or the end product which determines the processing method used: Large-scale volumes or small production runs, bulky or delicate parts, material which can be easily melted or difficult to process: the right processing method is on hand every time.

The product does not always go to the customer directly in finished form: several different divisions and production stages can be involved along the value chain in order to provide customers with a complete solution.

Many compounds are developed individually for specific sectors of industry and individual customers, and are produced in-house. These are then used, also internally, for injection moulding, profile extrusion or the extrusion of semi-finished products such as rods, plates or tubes.

During a subsequent machining process, extruded semi-finished products, injection moulded blanks and also cast primary products are used as starting products for the manufacture of precision finished parts. And our customers may rest easy in the assurance of our full compliance with stringent quality standards.

Strict guidelines and the deployment of a skilled workforce safeguard the individual process steps from incoming raw materials right through to the finished product.

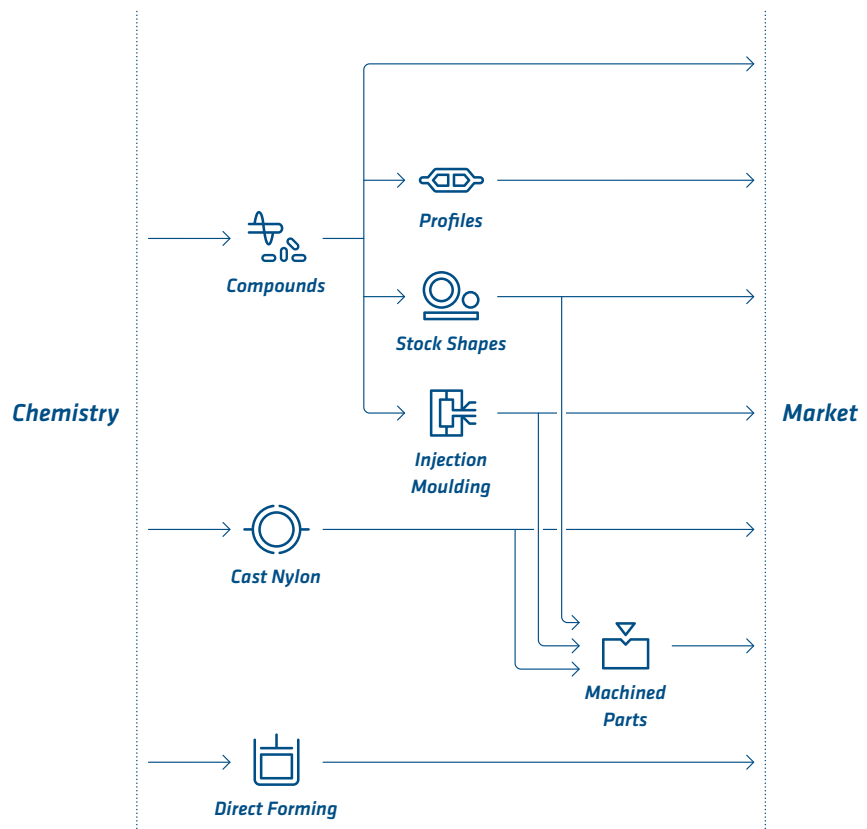

# Processing methods

**Compounds, semi-finished and finished products are manufactured with the aid of the following process techniques:**

## **Compounding**

During compounding, plastic raw materials are melted with fillers or additives, extruded into thin strands and then cut into granulate. This process allows the characteristics of the plastics to be adapted for special applications, for instance by improving the sliding friction properties or increasing electrical conductivity.



## **Extrusion**

Pressure and temperature-regulated extrusion is a continuous production process in which plastics are plastified in an extruder and then forced at pressure through a specially shaped die. The cross-section of the resulting geometric shape equates with the used die or calibration.

The extrusion process is an efficient method of manufacturing semi-finished products, also known as stock shapes, with large wall thicknesses and dimensions. The portfolio of semi-finished products comprises rods, tubes and plates in a wide variety of dimensions and colours.



## **Injection moulding**

Injection moulding is a highly productive forming process for the mass manufacture of finished components capable of immediate commercial use. The plastic is melted using an extruder, plasticized and then injected at pressure into the injection moulding tool. The cavity of the tool determines the shape and surface structure of the finished component. The injection moulding process is usually only economical for large production runs due to the tooling costs involved.

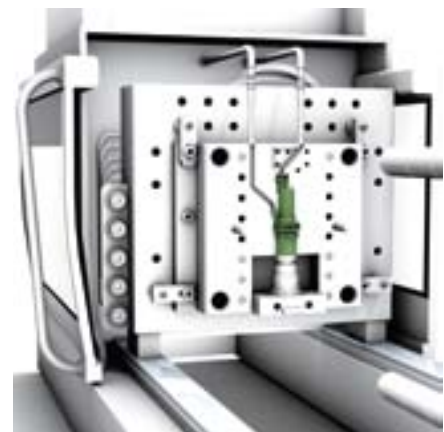



---

### **Compression moulding / sintering**

Compression moulding and sintering are used to produce stress-relieved semi-finished products and custom castings with a minimal tendency to warp. The so-called compression moulding technique is used to manufacture semi-finished products. The process uses powdered particles which are pressed at high temperature under pressure into a mould. Because of the amount of time involved and the materials used, this process is relatively labour intensive and costly. Unlike the compression moulding method, the matrix compression or direct forming technique allows the direct production of off-tool custom castings. As a special mould is required, this process is generally only profitable for a production run of around 1,000 pieces.



---

### **Cast polyamide**

Pressureless custom casting has proved to be a particularly successful method for the production of bulky thick-walled components which are almost fully finish processed. Alongside custom casting, cast polyamide semi-finished products can also be produced using the semi-finished product casting technique in the form of plates and rods with substantially larger dimensions than when using the extrusion method.

Semi-finished products and custom castings produced using this method have a lower intrinsic stress level than extruded products. Casting methods are ideally suited for small and medium-sized production volumes in a weight range of 0.5 to 900 kg.

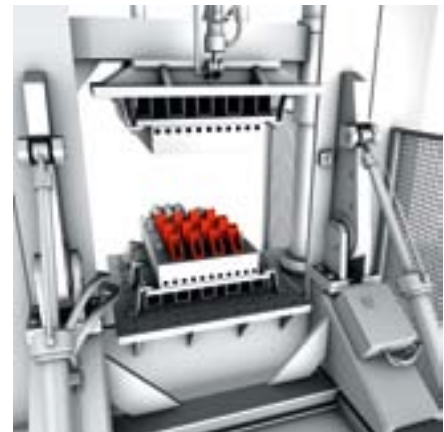

---

### **Machining**

Machining is the fastest, most economical way to arrive at a finished plastic component, in particular for small production runs. Using the machining technique, finished components with extremely close tolerances can be produced from engineering and high-temperature plastics. This entails the use of CNC milling machines, lathes or saws fitted with special tools for machining plastics to shape the finished parts from plastic stock shapes or pre-produced injection-moulded components.









# Materials

*Semi-finished and finished materials made of thermoset plastics are used throughout every sector of industry. The technical applications for these products include not only the automotive and mechanical engineering industries, but also include the food and pharmaceuticals industries, construction and transport, medical technology, electrical engineering, and also the aerospace industry.*

Ensinger offers a wide variety of different engineering plastics. These can often be purchased in a basic variant and also in a variety of modifications.

The different material groups are presented over the following pages together with a description of their typical properties, identifying characteristics, structure and so on. Characteristic application examples for the relevant materials are also listed.



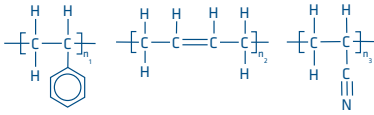

Structural formula ABS

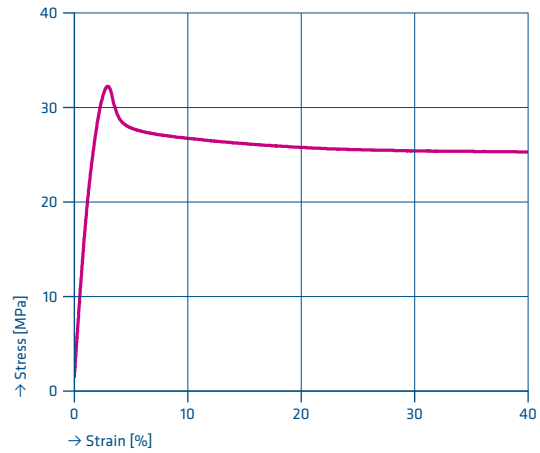

TECARAN ABS

# TECARAN ABS

## ABS (DIN designation)

ABS is a thermoplastic copolymerisate made from acrylonitrile, butadiene and styrene monomers. Using different combinations of these monomers, wide-ranging different ABS types can be manufactured offering a wide spectrum of different properties by means of branching or copolymerization. ABS is classified as an amorphous thermoplastic.

## Properties

- Opaque
- Low density
- High degree of toughness
- High strength and hardness
- High chemical resistance
- Moderately high thermal stability
- Gamma and X-ray resistance
- Very good machining properties
- Low moisture absorption
- Highly scratch-proof

## Values

### TECARAN ABS grey (ABS)

T <sub>g</sub>	104 °C
Density	1.04 g/cm <sup>3</sup>
Modulus of elasticity	1,700 MPa
Service temperature, long-term	75 °C
Service temperature, short-term	100 °C
Lower service temperature	-50 °C

## Identifying characteristics

- Colour grey
- High flammability
- Burns with a blue flame with yellow tip, sooting
- Sweetish odour
- Density over 1.04 g/cm<sup>3</sup> – floats in saline solution
- Dissolvable with acetone

## Products / Modifications

### TECARAN ABS (ABS)

Unreinforced basic type, very rigid and tough, very good electrical insulation properties

## Application examples

Parts such as mirror housings, interior panelling, loud-speaker covers, handle elements (automotive industry), household articles such as hair dryers and other technical appliances, housing components in the electronics industry, musical instruments such as recorders or clarinets.

## Summary

TECARAN ABS is harder and more scratch-proof than PET and POM but with lower thermal stability. The characteristics of the basic ABS type offer wide scope for modification by varying the proportion of components. By modifying with PC and PBT, a wide variety of tough, impact resistant types can be created, primarily for injection moulding.

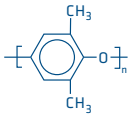

Structural formula PPE

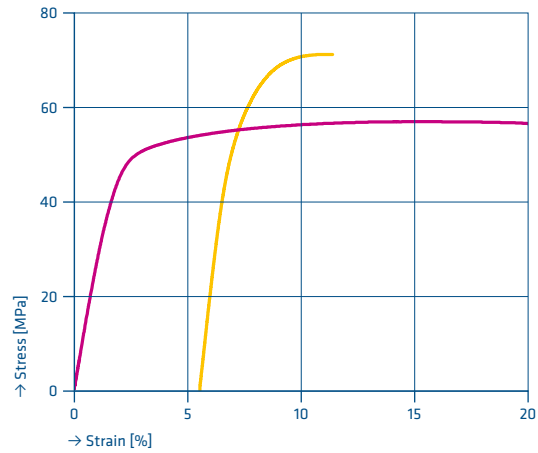

— TECANYL 731 grey — TECANYL GF30

# TECANYL

## PPE (DIN designation)

Polyphenylene ether (PPE) is an amorphous standard thermoplastic. PPE is usually only used when modified by the addition of PA or PS. By varying the proportion of the components, different modifications can be created to withstand higher thermal and mechanical loads. However, these have a negative impact on processability. As a result of modification and the addition of fillers such as glass fibre, the mechanical properties of the material can be varied even further.

## Properties

- Amorphous
- Low density, little over 1 g/cm<sup>3</sup>
- High toughness, strength, hardness and rigidity
- Creep resistant
- Good chemical resistance
- Tendency to stress crack formation
- Good thermal stability
- Very low moisture absorption
- Very good dimensional stability
- Very low dielectric constant

## Values

### TECANYL 731 grey (PPE)

T <sub>g</sub>	145 °C
Density	1.10 g/cm <sup>3</sup>
Modulus of elasticity	2,400 MPa
Service temperature, long-term	85 °C
Service temperature, short-term	110 °C
Lower service temperature	-50 °C

## Identifying characteristics

- Colour grey
- Very low flammability, sooting
- Burns with a blue flame with yellow tip
- Foul odour on thermal
- Density little over 1 g/cm<sup>3</sup> – floats in saline solution
- Very scratch-resistant, hard
- Dissolvable with acetone / benzene

## Products / Modifications

### TECANYL 731 grey (PPE)

Unreinforced basic type

### TECANYL MT (PPE)

Wide range of colours available for medical technology, biocompatible

### TECANYL GF30 (PPE GF)

Glass fibre reinforced for high strength, rigidity, high heat deflection temperature, low thermal expansion for precision and electrical insulating parts

## Application examples

Electrical insulation components with flame-retardant types, structural components with low warpage, scratch-proof high-gloss exposed parts (housing components for home electronics), coil formers for satellite technology, housings for railway track sensors, electrical adapters for underwater cable connectors used in oil and gas pipeline technology

## Summary

Due to its high dimensional stability and good impact strength, PPE is more suited than other standard plastics for use in housing components, also those exposed to high levels of stress. Consequently this material provides scope for the low-cost manufacture of suitable components.



Structural formula PE

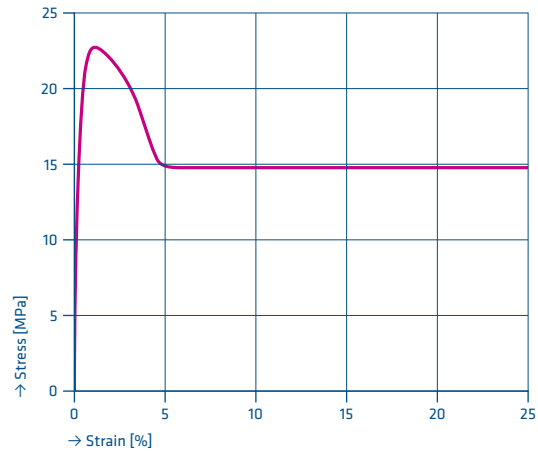

TECAFINE PE

## TECAFINE PE

### PE (DIN designation)

Polyethylene (PE) is a thermoplastic polymer produced by the polymerization of ethylene. In terms of the production quantity produced, polyethylene is among the largest group of plastics, the polyolefins. Because of its degree of crystallinity, PE belongs to the group of partially crystalline thermoplastics. The most commonly used types PE (PE-HD), PE 5 (PE-HMW), PE 10 (PE-UHMW) and the low-density polyethylene types (PE-LD, PE-LLD) differ in terms of their molecular weight and the degree of molecular chain branching.

### Properties

- Partially crystalline, low density
- High level of toughness, low strength and hardness
- Very good chemical resistance
- Low thermal stability, increasing with rising molecular weight
- Anti-adhesive properties
- Very high thermal expansion
- Very low dissipation factor
- Very good electrical insulation

### Values

	TECAFINE PE (PE)	TECAFINE PE 10 (PE)
T <sub>g</sub>	-95 °C	-95 °C
Density	0.96 g/cm <sup>3</sup>	0.93 g/cm <sup>3</sup>
Modulus of elasticity	1,000 MPa	650 MPa
Service temperature, long-term	90 °C	90 °C
Service temperature, short-term	90 °C	120 °C
Lower service temperature	-50 °C	-150 °C

### Identifying characteristics

- Colour opaque / milky white
- High flammability
- Burns with a blue flame with yellow tip
- Minimal or no sooting
- Waxy odour
- Density < 1g/cm<sup>3</sup>, floats in water
- Relatively soft, can be scored with a fingernail
- Subjectively very light to the touch

### Application examples

Guide rollers, chain guides, liners for silos and chutes, extraction and filter plates, pipes for gas and drinking water, underfloor heating systems in PE-HMW, systems for processing and packaging frozen food, films for a variety of industries

### Summary

The different polyethylene types differ in terms of their molecular weight. The crystallinity, chemical resistance, toughness and abrasion resistance properties of these materials improve with increasing molecular weight. Conversely, their processability by melting becomes more difficult. Ultra-high molecular weight polyethylenes (PE-UHMW) can only be processed by pressing into stock shapes or direct moulding. The benefit: semi-finished and finished products made of PE-UHMW demonstrate low internal stress and minimal warpage.

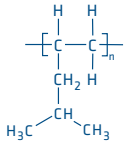

Structural formula PMP

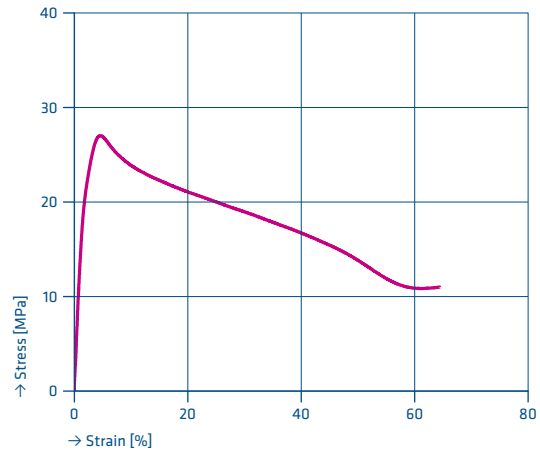

TECAFINE PMP

# TECAFINE PMP

## PMP (DIN designation)

Polymethylpentene (PMP) is a thermoplastic belonging to the polyolefine group. With a density of 0.83 g/cm<sup>3</sup>, it is the lightest of all the plastics. Despite its partially crystalline structure, PMP has a clear/transparent appearance.

## Properties

- Semi-crystalline
- Transparent
- Lowest density of all plastics
- High toughness, strength and hardness
- Good resistance to chemicals
- Stress crack resistance better in some cases than with other transparent plastics
- Water absorption can result in deformation
- Limited resistance to hydrolysis
- Good thermal stability
- Good gamma and X-ray resistance
- Very good electrical insulation properties
- Very low dissipation factor
- Outstanding optical properties

## Values

### TECAFINE PMP (PMP)

T <sub>g</sub>	20 °C
Density	0.83 g/cm <sup>3</sup>
Modulus of elasticity	1,000 MPa
Service temperature, long-term	120 °C
Service temperature, short-term	170 °C
Lower service temperature	-20 °C

## Identifying characteristics

- Colour opaque / slightly yellowish
- High flammability
- Burns with a blue flame with yellow tip
- Minimal or no sooting
- Waxy odour
- Density < 1 g/cm<sup>3</sup>, floats in water
- Relatively soft, can be scored with a fingernail

## Products / Modifications

### TECAFINE PMP (PMP)

Transparent, also in the UV range.  
Very good electrical insulation.

## Application examples

Medical technology: various injection mouldings for connecting and distributor elements used in parts for drip feeding, injections, various household appliances; Electro-technical accessories, high-frequency technology, coil cores, aerial supports, lenses for ultrasound applications

## Summary

Higher strength and thermal stability levels than PE. The crystallite size is lower than the wavelength of the light, permitting very good transparency. Better light transmission in the visible area than with optically highly transparent plastics such as PMMA or PC.



Structural formula PP

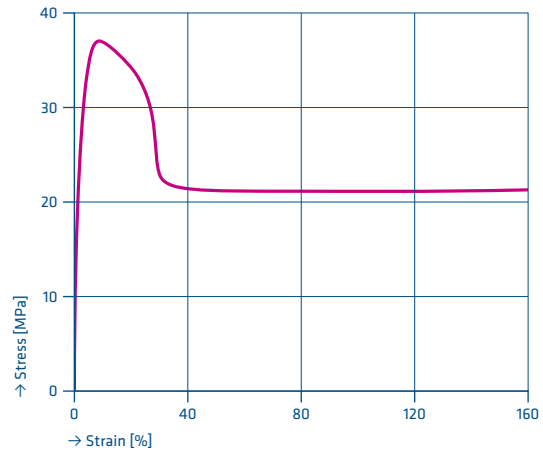

TECAFINE PP

# TECAPRO MT TECAFINE PP

## PP (DIN designation)

Polypropylene (PP) is a thermoplastic manufactured by the catalytic polymerization of propene. Polypropylene belongs to the group of polyolefines.

Polypropylenes (PP) are universal standard plastics with well-balanced properties. The Ensinger semi-finished product portfolio contains two main types of polypropylene: TECAPRO MT and TECAFINE PP.

## Properties

- Semi-crystalline
- Low density < 1 g/cm<sup>3</sup>
- High degree of toughness
- Better strength, hardness and rigidity than PE
- Very high chemical resistance
- Very low moisture absorption
- No stress crack formation
- Improved thermal stability compared to PE
- Anti-adhesive properties
- High thermal expansion
- Low application range in minus temperature range, sensitive to impact

## Values

	TECAPRO MT (PP)	TECAFINE PP (PP)
T <sub>g</sub>	-10 °C	-18 °C
Density	0.92 g/cm <sup>3</sup>	0.91 g/cm <sup>3</sup>
Modulus of elasticity	2,000 MPa	1,600 MPa
Service temperature, long-term	100 °C	100 °C
Service temperature, short-term	100 °C	130 °C
Lower service temperature	-10 °C	-10 °C



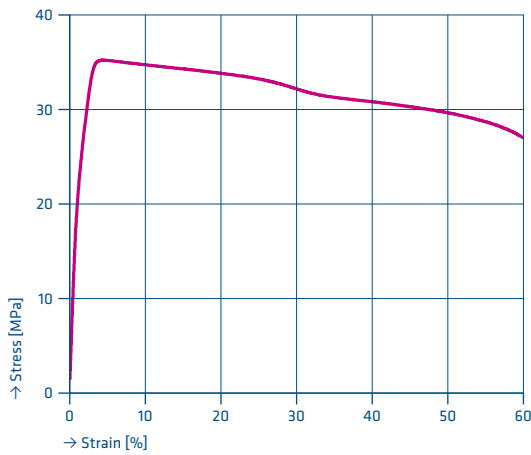

— TECAPRO MT

### Identifying characteristics

- Many criteria similar to PE
- Difference: Scoring with a fingernail is not possible
- Colour opaque / milky white
- High flammability
- Burns with a blue flame with yellow tip
- Minimal or no sooting
- Waxy odour
- Density < 1 g/cm<sup>3</sup>, floats in water

### Products / Modifications

#### TECAFINE PP (PP)

Unreinforced basic type, natural

#### TECAFINE PP GF30 (PP GF)

Glass fibre reinforced for high strength, rigidity, hardness and low thermal expansion, dimensional stability, preferred use for injection moulding

#### TECAPRO MT (PP)

Special type, modified for use in medical technology, biocompatible

### Application examples

TECAFINE PP: large-sized chemistry apparatus, acid-proof construction and acid baths, valves, galvanizing apparatus, pickling and etching baths, low-temperature exhaust gas flues, filter plates for filter presses, waste water plants, waste water piping systems, fittings made of extruded semi-finished products, transport crates for food, filter components, fittings, containers, food processing plants exposed to high levels of thermal and chemical stress. Used in large-format press platens with low warpage and good welding properties for chemical plants manufactured using daylight presses. TECAPRO MT: biocompatible material for use in medical technology, trays for the cleaning, sterilization and storage of different medical devices and components used in medical applications, simple handles, certain geometry adaptation models, body contact plates for mammography.

### Summary

The main difference between TECAFINE PP and TECAPRO MT is that TECAPRO MT is based on specially heat-stabilized PP homopolymer. This allows it to resist higher thermal stress during extended tempering, resulting in a more stress-relieved product and reducing the tendency to warp as a result of repeated super-heated steam sterilization. Easy to machine into dimensionally stable lightweight components.

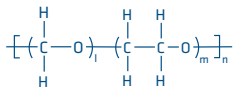

**Structural formula POM-C**

l and m statistically distributed

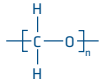

**Structural formula POM-H**

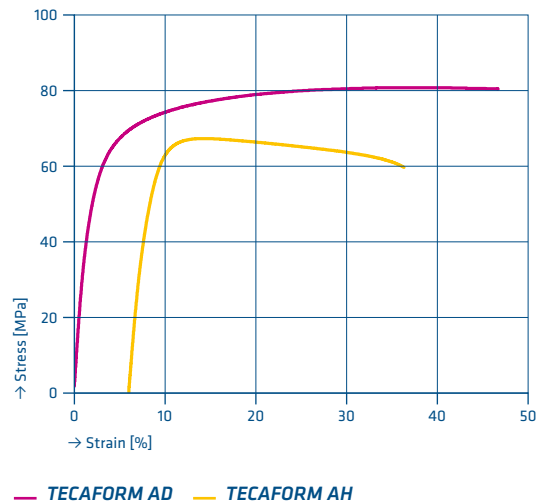

# TECAFORM

**POM (DIN designation)**

The different designations polyacetal, polyoxymethylene or polyformaldehyde (POM) are customary terms to describe the same polymer in different languages. POM is a thermoplastic produced by the polymerization of formaldehyde. Two typical groups of polyacetals exist: homopolymers (POM-H / TECAFORM AD) and copolymers (POM-C / TECAFORM AH). Both differ in terms of their manufacturing process. Although their properties are very similar, they do demonstrate a number of typical differences.

**Properties**

- High crystallinity
- Relatively high density
- Good degree of toughness, also in the low temperature range
- High strength, hardness and spring stiffness
- Very good sliding friction properties, abrasion-resistant, anti-adhesive
- High chemical resistance, especially to alkalis, solvents and fuels
- Good thermal stability
- Low moisture absorption
- Good dimensional stability
- Very low dielectric constant

**Values**

	TECAFORM AD (POM-H)	TECAFORM AH (POM-C)
T <sub>g</sub>	-60 °C	-60 °C
Density	1.43 g/cm <sup>3</sup>	1.41 g/cm <sup>3</sup>
Modulus of elasticity	3,600 MPa	2,800 MPa
Service temperature, long-term	110 °C	100 °C
Service temperature, short-term	150 °C	140 °C
Lower service temperature	-50 °C	-50 °C

**Identifying characteristics**

- Colour white, slightly opaque, slightly translucent at the edges
- High flammability
- Burns with a faint blue flame with yellow tip, produces droplets and continues to burn
- Minimal or no sooting
- Typically gives off pungent odour of formaldehyde on thermal decomposition
- High density, sinks in water
- Slightly waxy feel
- Quickly destroyed in mineral acids
- Muffled sound on impact

---

### **TECAFORM AD und AH**

To address the wide-ranging different requirements occurring in industry, a wide range of materials is available which are adjusted to suit specific application conditions. Products are available for use in the food, drinking water, pharmaceutical and medical technology industries and also for sliding applications. Also available are materials required to comply with safety and explosion protection requirements, and products for consumer protection in the manufacture of foods and pharmaceuticals.

---

### **Products / Modifications**

#### **TECAFORM AD natural (POM-H)**

Basic type POM-H

#### **TECAFORM AD black (POM-H)**

For improved UV protection in outdoor use

#### **TECAFORM AD AF (POM-H, solid lubricant)**

Sliding properties modified with PTFE for minimal friction, brown

#### **TECAFORM AH natural (POM-C)**

Basic type POM-C

#### **TECAFORM AH black (POM-C)**

For improved UV protection for outdoor use

#### **TECAFORM AH ELS (POM-C, conductive carbon black)**

Adjusted for electrical conductivity for the reliable dissipation of static electricity and to protect products and systems against damage

#### **TECAFORM AH GF25 (POM-C GF)**

Glass fibre reinforcement for higher strength and precision

#### **TECAFORM AH ID (POM-C, detectable filler)**

Inductively detectable using sensors for the protection of food products, consumers and equipment

#### **TECAFORM AH ID blue (POM-C, detectable filler)**

Inductively detectable and additionally with blue, food-safe signal colour for food product protection

#### **TECAFORM AH LA blue (POM-C, solid lubricant)**

Sliding properties modified and blue signal colour for food contact

#### **TECAFORM AH MT coloured (POM-C)**

Coloured for use in medical technology, tested for biocompatibility

#### **TECAFORM AH SAN (POM-C)**

With antimicrobial finish for hygiene and health care applications

#### **TECAFORM AH SD (POM-C, antistatic)**

Electrostatically conductive for product protection in the electronics industry

---

### **Application examples**

POM with its broad type diversity is an engineering plastic for wide-ranging universal applications in many different branches of industry, also as a substitute for metal.

Comprehensive use for sliding applications, excellent design solutions with snap fastenings, sliding parts such as bearing bushes, rollers, slide rails, electrical insulating parts, components with contact to water, various fixture components with sliding function, scratch proof high-gloss exposed parts, wide range of components in the food, pharmaceutical and drinking water industries and in medical technology

---

### **Summary**

The two basic types are differentiated in the main by only a few underlying criteria:

- POM-H (homopolymer) has a high melting point and higher strength, but is sensitive to hydrolysis with continuous exposure to hot water over 60 °C and steam.
- POM-C (copolymer) has slightly lower strength but better toughness, better resistance to alkalis and good hydrolysis resistance to hot water and steam.
- POM-C can be manufactured in larger, thicker-walled semi-finished product dimensions.

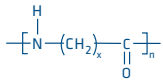

**Structure using one source material:**

PA 6: x=5

PA 11: x=10

PA 12: x=11

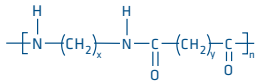

**Structure using two source materials:**

PA 66: x=6; y=4

PA 610: x=6; y=8

PA 612: x=6; y=10

**Unreinforced**

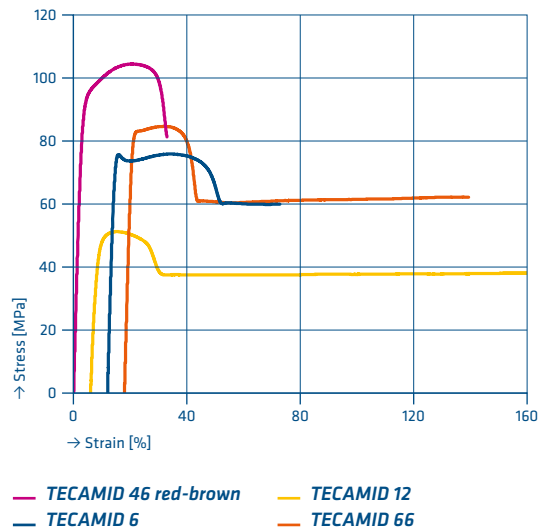

# TECAMID

**PA (DIN designation)**

TECAMID (PA) belongs to the extensive group of polyamides. Polycondensation allows the manufacture of a wide range of individual polyamides with different characteristics on the basis of one (e.g. PA 6, PA 11, PA 12) or more source materials (e.g. PA 66, PA 46, PA 610, PA 612). Polyamides are among the most important technical thermoplastics.

**Properties: PA 6 and PA 66**

- Semi-crystalline
- Low density, slightly over 1 g/cm<sup>3</sup>
- High thermal stability  
(melting point of PA 66 higher than PA 6)
- High strength and hardness
- High moisture absorption, which impairs most characteristic values to a greater or lesser degree: toughness, notch impact strength and abrasion resistance improve while other mechanical and electrical characteristic values deteriorate
- Very good toughness depending on moisture content
- Very high chemical resistance, primarily to alkalis, solvents and fuels
- Sensitivity to stress cracking only under very dry conditions
- Anti-adhesive properties

**Properties: PA 46**

- Semi-crystalline
- Low density, slightly over 1 g/cm<sup>3</sup>
- Extremely high thermal stability
- High thermal dimensional stability
- Very high moisture absorption compared to other polyamides. This property impairs most characteristic values to a greater or lesser degree: toughness, notch impact strength and abrasion resistance improve while other mechanical and electrical characteristic values deteriorate
- Very good toughness depending on moisture content
- Very high chemical resistance, primarily to alkalis, solvents and fuels
- Sensitivity to stress cracking only under very dry conditions

**Properties: PA 12**

- Semi-crystalline
- Low density, slightly over 1 g/cm<sup>3</sup>
- Medium strength and hardness
- Medium thermal stability
- Very low moisture absorption compared to other polyamides
- Very good impact strength and notch impact strength
- Very high chemical resistance, primarily to alkalis, solvents and fuels
- Very good stress cracking resistance

## Reinforced

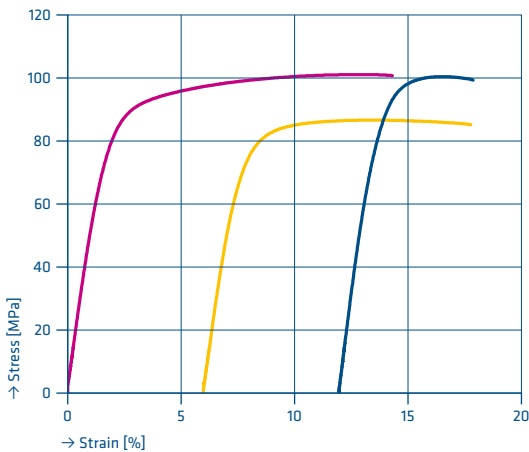

— TECAMID 66 CF20      — TECAMID 66 GF30 black  
 — TECAMID 6 GF30 black

## Values

	TECAMID 6 (PA 6)	TECAMID 66 (PA 66)	TECAMID 46 (PA 46)	TECAMID 12 (PA 12)
T <sub>g</sub> [°C]	45	47	72	37
Density [g/cm <sup>3</sup> ]	1.14	1.15	1.19	1.02
Modulus of elasticity [MPa]	3,300	3,500	3,300	1,800
Service temperature, long-term [°C]	100	100	130	110
Service temperature, short-term [°C]	160	170	220	150
Lower service temperature [°C]	-40	-30	-40	-60
Water absorption [%]	9.5	8.5	12	1.5

## Identifying characteristics

- Colour opaque / milky white
- High flammability
- Burns with a blue flame with yellow tip, no or only minimal sooting
- Horn-like odour when burning, produces melted droplets, draws threads
- Density slightly above 1 g/cm<sup>3</sup>, floats in saturated salt solution
- Translucent with thin wall thicknesses / at the edges

## Application examples

The PA group of plastics are classical universal materials used in mechanical engineering applications whose high toughness and abrasion resistance makes them very suitable as sliding materials. PA components ensure smooth, low-noise, low-vibration running, with emergency running characteristics for partial dry running.

More suitable for applications in tough hostile environments in which a wider tolerance range is admissible (note: precision components are less suitable for such applications due to variable moisture absorption).

## Products / Modifications

### TECAMID 6 (PA 6)

Unreinforced version, very tough, good damping properties, moisture absorption

### TECAM 6 MO (PA 6 MoS<sub>2</sub>)

Universal type, for outdoor use, sliding applications, abrasion resistant

### TECAMID 6 GF25

### TECAMID 6 GF30 (PA 6 GF)

Fibre reinforced for strength and rigidity coupled with a good level of toughness

### TECAMID 66 (PA 66)

Unreinforced basic type, harder and stronger than PA 6

### TECAMID 66 CF20 (PA 66 CF)

Carbon fibre-reinforced, high strength, improved UV protection

### TECAMID 66 GF30 (PA 66 GF)

Glass fibre-reinforced for high strength, improved UV protection for outdoor weather resistance

### TECAMID 66 HI

### (PA 66, heat stabilizer)

Thermally stabilized for permanently improved thermal stability

### TECAMID 66 LA

### (PA 66, solid lubricant)

With lubricant for improved sliding properties

### TECAMID 66 MH (PA 66 MoS<sub>2</sub>)

Enhanced abrasion resistance, also for external applications exposed to UV

### TECAMID 66 X GF50 (PA 66 GF)

Highly reinforced with 50 % GF, improved thermal stability, black

### TECAMID TR (PA 6-3)

Amorphous, transparent, very good electrical insulation

### TECAMID 12 (PA 12)

Low water absorption, characteristics remain stable in humid environments, very good electrical insulation, good slide friction properties, wear resistant, dimensionally stable

### TECAMID 46 (PA 46)

High-temperature PA, red-brown, almost exclusively used for injection moulding

## Summary

Because of its relatively high but reversible moisture absorption, PA 6 has a level of toughness which is high but varies depending upon climatic conditions.

PA 12 absorbs little water, has greater dimensional stability and is tough and wear resistant. TECAMID TR is transparent, tends to absorb hardly any moisture, has good electrical insulating properties.

TECAMID 46 has the highest level of toughness and water absorption, is wear resistant and has very high thermal stability.

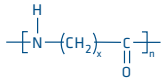

Structural formula PA 6 C



TECARIM (PA + elastomer)

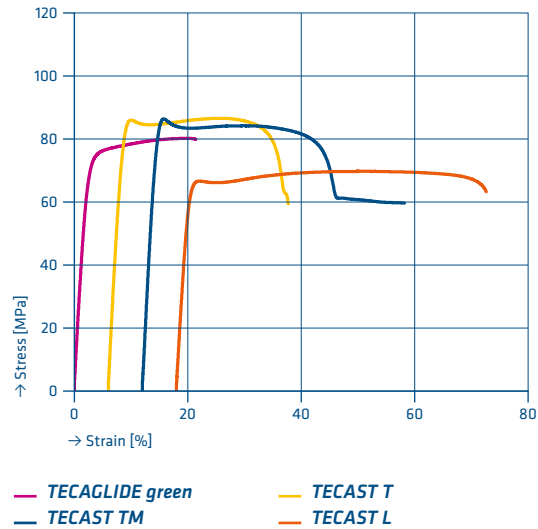

# TECAST TECARIM

## PA 6 C (DIN designation)

Due to the special manufacturing method used, TECAST and TECARIM represent a special group within the polyamide family. TECAST is a cast polyamide 6 product manufactured by the activated anionic polymerization of caprolactam. This cast polyamide material has high strength and rigidity, as well as good abrasion resistance, particularly against sliding friction partners with rough surfaces. Modifications using fillers, additives and lubricants are possible. TECARIM assumes a special position within this group, as in this case elastomer components are additionally polymerized as block copolymers.

## Properties: TECAST T, TECAST L, TECAGLIDE

- Semi-crystalline
- Low density, slightly over 1 g/cm<sup>3</sup>
- High thermal stability
- High strength and hardness
- High moisture absorption, which impairs most characteristic values to a greater or lesser degree: toughness, notch impact strength and abrasion resistance improve while other mechanical and electrical characteristic values deteriorate
- Very good toughness depending on moisture content
- Very high chemical resistance, primarily to alkalis, solvents and fuels
- Sensitivity to stress cracking only under very dry conditions
- Anti-adhesive properties

## Properties: TECARIM

- Polyamide 6-block copolymer with high load capacity
- Toughness modification of PA 6 C by the addition of elastomer
- Balanced toughness and rigidity
- Production using the RIM method (Reaction Injection Moulding)
- Robust, abrasion-resistant components capable of withstanding extreme loads
- Extremely high impact strength, also down to -40 °C
- Good abrasion and wear resistance
- High energy and shock absorption
- No brittle fractures under pressure or impact loads
- Stress-relieved and draft-free moulded components

## Values

	<b>TECAST T (PA 6 C)</b>	<b>TECARIM (PA 6 C)</b>
T <sub>g</sub>	40 °C	53 °C
Density	1.15 g/cm <sup>3</sup>	1.11 g/cm <sup>3</sup>
Modulus of elasticity	3,500 MPa	2,200 MPa
Service temperature, long-term	100 °C	95 °C
Service temperature, short-term	170 °C	160 °C
Lower service temperature	-40 °C	-50 °C

## Identifying characteristics

- Colour opaque / milky white
- High flammability
- Burns with a blue flame with yellow tip, no or only minimal sooting
- Horn-like odour when burning, produces melted droplets, draws threads
- Density slightly above 1 g/cm<sup>3</sup>, floats in saturated salt solution
- Translucent with thin wall thicknesses / at the edges

## Products / Modifications

### **TECAST T (PA 6 C)**

Basic type, tough-hard, very good machining properties

### **TECAGLIDE green (PA 6 C, solid lubricant)**

Cast PA 6, sliding properties modified for very low friction

### **TECAST L (PA 6 C, oil)**

Sliding properties modified

### **TECAST L black (PA 6 C, oil)**

Sliding properties modified, black, also for outdoor exposure to weather

### **TECAST L yellow (PA 6 C, oil)**

Sliding properties modified, yellow

### **TECAST TM (PA 6 C, MoS<sub>2</sub>)**

With MoS<sub>2</sub>, improved abrasion resistance, suitable for outdoor exposure to UV

### **TECARIM 1500 yellow (PA 6 C, elastomer)**

Signal colour yellow, high toughness, good low temperature impact strength

## Application examples

Pulleys and guide rollers, chain guides, slide rails. The adjustable toughness properties of TECAST T are used in damping plates for impact and vibration hammers applied for pile driving; large-scale gears used for the transfer of motion rather than power transmission.

Due to its high toughness, TECARIM is also used at low temperatures for winter technology applications (chain supports, chain buffers for bulldozers); Stress relief blocks for punching, deep drawing in automotive production, white goods, tool building

## Summary

Due to its relatively high but reversible moisture absorption, PA 6 has a high level of toughness, whereby TECAST T demonstrates even higher crystallinity and better machinability than PA 6.

TECAST L and TECAGLIDE are special types with modified sliding properties for improved sliding friction properties and reduced abrasion.

Several TECARIM types can be varied over wide ranges (in terms of strength, creep strength and toughness from tough elastic to hard).

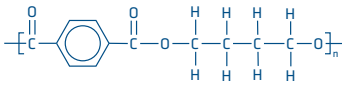

Structural formula PBT

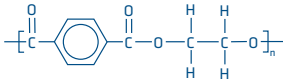

Structural formula PET

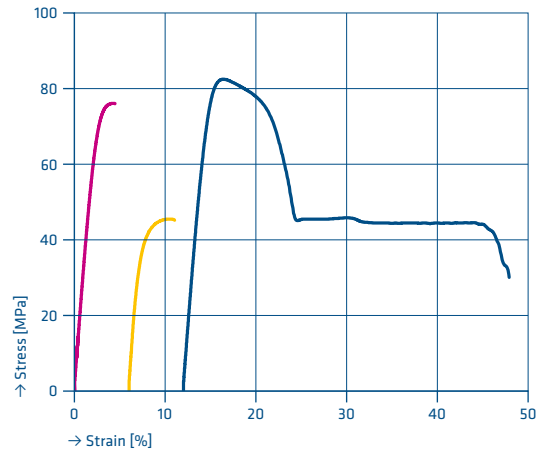

— TECAPET TF — TECADUR PBT GF30 — TECAPET

# TECADUR TECAPET

## PET, PBT (DIN designation)

Polyethylenterephthalate (PET) is manufactured using a polycondensation reaction from terephthalic acid and ethylene glycol. PET belongs to the group of thermoplastic linear polyesters and encompasses both TECAPET and the related non-standard types TECADUR PET. Another type is TECADUR PBT, which is similar in character to PET, with lower strength but particularly good toughness and abrasion resistance.

Due to these properties, TECADUR PBT is significantly easier to modify with fibres than PET, and therefore generally available as a fibre-reinforced product (TECADUR PBT GF30).

## Properties

- Semi-crystalline
- Relatively high density
- High degree of toughness, spring stiffness
- Brittle behaviour at low temperatures below zero degrees
- High strength, hardness and rigidity
- Very good sliding friction properties, abrasion-resistant
- High chemical resistance, preferably resistant to diluted acids
- Good thermal stability
- Very low moisture absorption
- Minimal thermal expansion
- Very good dimensional stability
- Hydrolysis-sensitive to hot water and steam
- Very good electrical insulation properties

## Values

	TECADUR PET (PET)	TECAPET (PET)	TECADUR PBT GF30 (PBT GF)
T <sub>g</sub>	81 °C	81 °C	60 °C
Density	1.39 g/cm <sup>3</sup>	1.36 g/cm <sup>3</sup>	1.46 g/cm <sup>3</sup>
Modulus of elasticity	3,300 MPa	3,100 MPa	3,400 MPa
Service temperature, long-term	110 °C	110 °C	110 °C
Service temperature, short-term	170 °C	170 °C	200 °C
Lower service temperature (increasing brittleness)	-20 °C	-20 °C	-20 °C



---

### Identifying characteristics

- Colour white, good coverage, more intensive than POM
- High flammability
- Burns with luminous yellow flame
- High level of sooting
- Typical sweetish, irritant odour on thermal decomposition

---

### Products / Modifications

#### **TECADUR PET (PET)**

Basic type unreinforced

#### **TECAPET (PET)**

Modified for better machining

#### **TECAPET schwarz (PET)**

Improved for external use with UV protection

#### **TECADUR PBT GF30 (PBT GF)**

Glass fibre reinforced, for high strength, rigidity and precision requirements

#### **TECAPET TF (PET TF)**

Modified as a sliding friction type with PTFE additive

---

### Application examples

Sliding parts such as bearing bushes, rollers, slide rails, very good suitability for snap-effect installations, electrical insulating components, components with cold water contact, various fixture parts with sliding effect, scratch-proof high-gloss exposed parts, engineering plastic for universal applications, components for food processing plants

---

### Summary

Products based on PET are used where moisture absorption must be avoided and where dimensional stability is required in conjunction with strength. Lower water absorption and thermal expansion than with PA and POM make PET ideally suited for dimensionally stable precision components with minimal environmental dependency. When used in food-related applications, resistance to typical cleaners plays a decisive role. PET is more resistant to different cleaning acids than POM and PA, but conversely does not tolerate alkaline cleaning agents (caustic soda).

The material TECAPET is a special modification providing improved toughness, better sliding friction properties with slightly reduced strength, and primarily improved machinability.

TECAPET black is the black dyed version with improved UV protection for external applications.

TECAPET TF is a variant with improved sliding friction properties with added polymer solid lubricant TECADUR PBT GF30. It is the glass-fibre reinforced modification based on the related but significantly tougher PBT for higher strength requirements, high rigidity and low thermal expansion, making it ideally suited for structural components with a high level of precision used in electrotechnical applications, precision mechanics and mechanical engineering. PET is in any case highly rigid. Due to the high level of brittleness, with the addition of glass fibre it could not be further processed without damage.

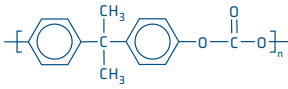

Structural formula PC

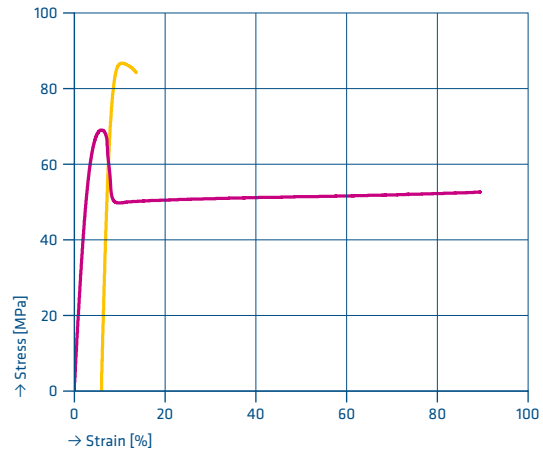

— TECANAT — TECANAT GF30

# TECANAT

## PC (DIN designation)

Polycarbonate (PC) is manufactured by the reaction of bisphenol A with phosgene, and belongs to the group of linear thermoplastic polyesters. Due to its low crystallinity, PC has a high level of transparency.

The plastic is characterized by high strength, rigidity and hardness, as well as very good impact strength. In contrast to their low chemical resistance, polycarbonates are very resistant to external influences such as weather and UV-radiation.

## Properties

- Amorphous
- High degree of transparency
- Low density
- Good thermal stability
- Very high toughness
- Very high impact strength, even at low temperatures
- High strength and hardness
- Maintains its rigidity over a wide range of temperatures
- Very high dimensional accuracy
- Low moisture absorption
- Moderate chemical resistance, sensitive to solvents and alkalis

- Tendency to stress crack formation
- Sensitive to notching
- Unsuitable for high mechanical loads
- Hydrolysis-sensitive (to continuous exposure to hot water and primarily super-heated steam)
- Low dissipation factor
- Good electrical insulation properties
- Very good resistance to weathering

## Values

	TECANAT (PC)	TECANAT GF30 (PC GF)
T <sub>g</sub>	149 °C	147 °C
Density	1.19 g/cm <sup>3</sup>	1.42 g/cm <sup>3</sup>
Modulus of elasticity	2,200 MPa	4,400 MPa
Service temperature, long-term	120 °C	120 °C
Service temperature, short-term	140 °C	140 °C
Lower service temperature (increasing brittleness)	-60 °C	-40 °C

## Identifying characteristics

- Colourless
- Highly transparent
- High flammability
- Burns with luminous yellow flame, heavy sooting
- Sweetish odour, irritant
- Density 1 g/cm<sup>3</sup> – floats in saline solution
- Subject to rapid attack by solvents, clouding of the surface

---

## **Products / Modifications**

### **TECANAT (PC)**

Unreinforced basic types

### **TECANAT GF30 (PC GF)**

Glass fibre reinforced for high strength and rigidity, dimensional stability

### **TECANAT MT (PC)**

Natural special types for use in medical technology, biocompatible

---

## **Application examples**

Areas in which high transparency and mechanical characteristics such as impact strength, strength and dimensional stability are key, such as electrical and apparatus components, CDs and DVDs. Spectacle lenses and optical lenses, lamp covers, viewing windows used in food technology or mineral oil processing. Also lenses for car headlamps, aircraft windows, safety screens, burglar-resistant glazing, underwater housings for cameras, conservatory and greenhouse glazing, solar panels, covers, packaging, suitcases, protective helmets and visors.

Also suitable as a housing material for cameras, mobile phones, laptops and other housings, as well as durable identification documents.

Special PC types can be used as a raw material for a wide range of different disposable medical products.

---

## **Summary**

Compared to other engineering plastics, polycarbonate demonstrates excellent impact strength and low temperature impact strength as well as exceptional transparency. Due to its high degree of hardness, PC is less susceptible to scratches and so maintains a high level of transparency in application. This distinguishes it from other materials and opens up a wide range of applications across different fields.

The high strength and toughness of the glass-fibre reinforced type TECANAT GF30 makes it particularly suited for use in electrically insulating components and in structural and housing components requiring a high standard of dimensional stability, strength and impact strength. Unlike unmodified types, fibre-reinforced PC is not transparent but has a greyish opaque colour.

The special type TECANAT MT is suitable for one-off applications in the medical sector. However, the highly-transparent material offers only minimal resistance to superheated steam. Even a few sterilization and cleaning cycles exert a significant detrimental effect on the material (stress crack formation, yellowing, brittleness).

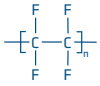

**Structural formula PTFE**

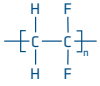

**Structural formula PVDF**

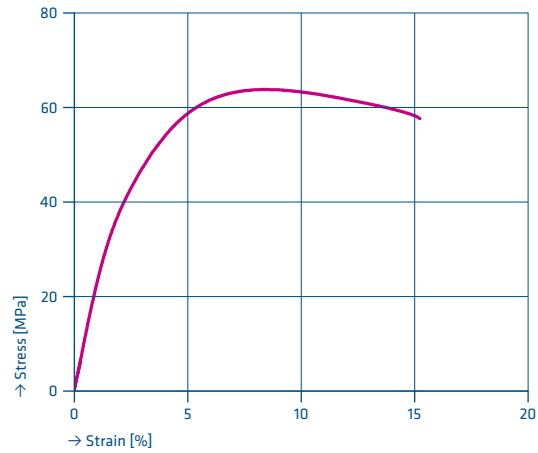

**TECAFLON PVDF**

# TECAFLON

## **PVDF, PTFE (DIN designation)**

Polyvinylidene fluoride (PVDF) and polytetrafluoroethylene (PTFE) belong to the group of highly chemically resistant fluorothermoplastics. Due to its high molecular weight, highly chemically resistant PTFE cannot be processed by melting, but only by pressing and sintering to create semi-finished products. PVDF can be formed by extrusion.

### **Properties: PVDF**

- High density
- Strong and tough
- Minimal toughness at low temperatures
- High chemical resistance
- Hydrolysis-resistant
- Very low moisture absorption
- High thermal expansion
- High dissipation factor, polar, not suitable for high-frequency applications
- High resistance to UV radiation
- PVDF is significantly more resistant to energetic radiation than all other fluorothermoplastics
- Inherently flame resistant, self-extinguishing
- Releases highly toxic gas in case of fire

### **Properties: PTFE**

- Very high crystallinity
- Highest density of all polymers
- Very tough down to low temperatures
- Minimal strength and hardness
- Poor creep strength
- Extremely high resistance to chemicals, also to oxidizing acids
- Hydrolysis-resistant
- No stress crack formation
- Very low moisture absorption
- High thermal stability, but low dimensional stability at temperature
- Anti-adhesive properties, very good sliding properties, no stick-slip behaviour
- High resistance to UV radiation
- Very sensitive to severe radiation (gamma and X-rays)
- Not bondable with conventional materials
- High thermal expansion
- Minimal dissipation factor
- Very good electrical insulation properties due to their low microstructure density, RAM extruded products offer characteristics such as minimal dielectric strength under high voltage)
- Inherently flame resistant, self-extinguishing
- Combustion gases are fluoric, highly toxic

## Values

	<b>TECAFLON PVDF (PVDF)</b>	<b>TECAFLON PTFE (PTFE)</b>
T <sub>g</sub>	-40 °C	-20 °C
Density	1.78 g/cm <sup>3</sup>	2.15 g/cm <sup>3</sup>
Modulus of elasticity	2,200 MPa	700 MPa
Service temperature, long-term	150 °C	260 °C
Service temperature, short-term	150 °C	260 °C
Lower service temperature	-30 °C	-200 °C (Exceptions down to -270 °C)

## Identifying characteristics: PVDF

- Colour opaque / milky white
- Low flammability
- Burns with luminous yellow flame
- Extinguishes after removing the flame
- Irritant odour
- High density (tangibly evident)
- Difficult to score with a fingernail

## Identifying characteristics: PTFE

- Radiant white, opaque
- Low flammability
- Does not burn
- Irritant odour
- High density (tangibly evident)
- Soft, easily deformable, easily scored using a fingernail

## Products / Modifications

### TECAFLON PVDF (PVDF)

Unreinforced basic types

### TECAFLON PVDF ELS

(conductive carbon black)

electrically conductive

### TECAFLON PTFE (PTFE)

Unreinforced basic types

## Application examples

PTFE is the most commonly used and important fluoropolymer with the most extensive fields of application: Chemical plant engineering, food and pharmaceutical technology. PTFE is preferred for sliding applications with exposure to extreme chemical stress. PVDF is ideal for chemical plant construction and high pressure loads under exposure to elevated temperatures, for valves, filter plates, fittings, pipelines, special types for ultra-pure water treatment plants.

## Summary

When determining the dimension of PTFE parts, consideration must be given to the extreme increase in the coefficient of thermal expansion as a result of microstructure changes taking place in the range of around 18 °C to 20 °C. Dimensions should be defined at a range of appr. 23 °C. PVDF has higher strength, with strength values at 150 °C still approximately as high as PTFE at room temperature. PVDF has lower chemical resistance than PTFE. The reinforcement of PVDF and PTFE with glass fibres is only recommended when taking special precautionary measures and using selected additives due to a possible thermal degradation reaction resulting in a release of gas and deflagration.

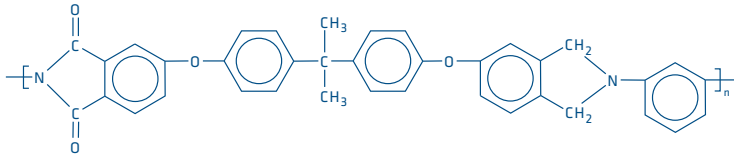

Structural formula PEI

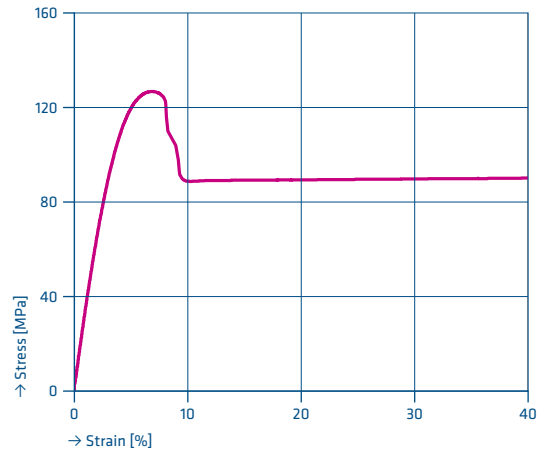

TECAPEI

# TECAPEI

## PEI (DIN designation)

Polyetherimide (PEI) is an amorphous thermoplastic with high mechanical strength and rigidity. Due to its characteristics, PEI has a great affinity to the group of polyarylsulphones (PSU, PPSU) but belongs to the thermoplastic polyimides group. The material demonstrates a remarkably high creep strength over a wide temperature range. PEI also demonstrates a high long-term service temperature. The characteristic profile is rounded off by very good hydrolysis resistance and dimensional stability. Due to its amorphous molecular structure, PEI is transparent and has a golden yellow colour.

## Properties

- Amorphous
- Transparent with thin wall thicknesses and polished surface
- Low density
- High strength, hardness and rigidity
- High degree of toughness
- High thermal stability
- Very high chemical resistance
- Very low moisture absorption
- Minimal thermal expansion
- Dimensionally stable
- Caution with strong solvents, stress crack formation possible
- Super-heated steam and hydrolysis-resistant
- Low dissipation factor, suitable for high-frequency applications
- Permeable by and resistant to microwaves
- Very good electrical insulation properties
- Inherently flame resistant, self-extinguishing
- High limiting oxygen index
- Very low energy release and minimal proportion of toxic gases in case of fire
- Good machining properties

---

### Values

	<b>TECAPEI (PEI)</b>
T <sub>g</sub>	216 °C
Density	1.28 g/cm <sup>3</sup>
Modulus of elasticity	3,200 MPa
Service temperature, long-term	170 °C
Service temperature, short-term	200 °C
Lower service temperature (increasing brittleness)	-50 °C

---

### Identifying characteristics

- Colour translucent, amber coloured
  - Burns with luminous yellow flame
  - Extinguishes slowly after removing the flame
  - Dissolves in methylene chloride
- 

### Products / Modifications

#### **TECAPEI (PEI)**

Unreinforced basic type, suitable for contact with foodstuffs

#### **TECAPEI MT (PEI)**

Special type for medical technology applications with biocompatibility

#### **TECAPEI GF30 (PEI GF)**

Processing to produce non-standard products, glass fibre reinforced for very high strength, metal replacement

---

### Application examples

Food and pharmaceutical plants, chemical and lab equipment, plug components, lampholders, soldering frames, special types for aerospace applications, electrical engineering, high-frequency aerial holders, coil formers, microwave equipment, microelectronics, test adapters

---

### Summary

The amorphous high-temperature plastics PEI, PPSU, PES and PSU generally offer very similar characteristic profiles; they differ predominantly in terms of the thermal values service temperature and glass transition temperature. However, PEI has significantly higher mechanical characteristics than polysulphones in respect of strength, rigidity and hardness. In addition, PEI has the lowest heat development rate in case of fire. This is a key criterion in aerospace applications.

With its non-standard types, PEI is an invaluable high-temperature plastic for these sectors.

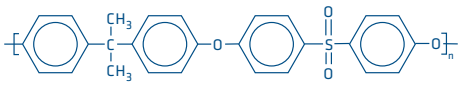

Structural formula PSU

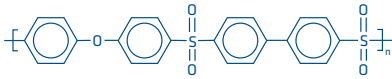

Structural formula PPSU

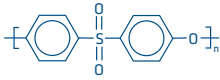

Structural formula PES

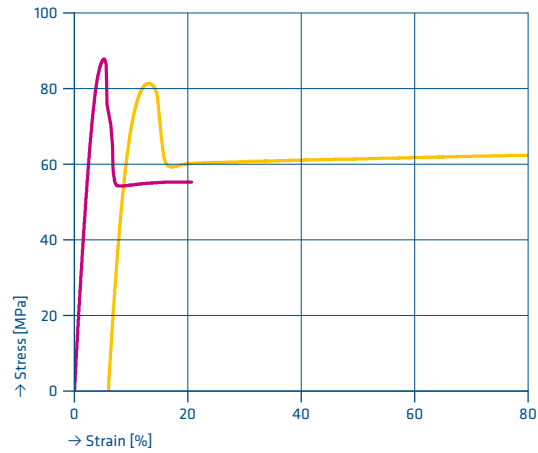

— TECASON S — TECASON P MT black

## TECASON S, P, E

### PSU, PPSU, PES (DIN designation)

Polyaryl sulphones (PSU, PPSU, PES) are a family of thermoplastic, amorphous and polar polymers. Due to their amorphous molecular structure, polyaryl sulphones are translucent and have a yellowish brown (amber coloured) transparent appearance. Even at high temperatures, these materials demonstrate a high level of strength and stability. Polyphenyl sulphone (PPSU) combines a high melting temperature with very low moisture absorption. In addition, this polymer offers better impact strength and chemical resistance than PSU and PES from the group of polysulphones. Alongside these characteristics, compared to other representatives of this polymer class, PPSU lends itself far better to superheated steam sterilization and has better resistance to cleaning agents and disinfectants.

The outstanding characteristics of polysulphones (PSU) include not only a high long-term service temperature but also remarkably high creep strength over a wide temperature range. A high level of dimensional stability and good hydrolysis resistance complete the product characteristics. The characteristics of polyether sulphone (PES) are similar to those of PSU. PES offers high mechanical strength and rigidity coupled with relatively low notch sensitivity. In addition, PES offers good chemical resistance and hydrolysis resistance. Compared to PSU, PES offers better chemical resistance and higher impact strength.

### Properties

- Amorphous
- Transparent with thin wall thicknesses and polished surface
- Low density
- High strength, hardness and rigidity
- High degree of toughness
- High thermal stability
- High chemical resistance
- Very low moisture absorption
- Good dimensional stability
- Caution with strong solvents, stress crack formation possible
- Super-heated steam and hydrolysis-resistant
- Low dissipation factor
- Permeable and with high resistance to microwaves, good for high-frequency applications
- Very good electrical insulation properties
- Inherently flame resistant, self-extinguishing
- Good machining properties



## Values

	<b>TECASON P (PPSU)</b>	<b>TECASON S (PSU)</b>
T <sub>g</sub>	218 °C	188 °C
Density	1.31 g/cm <sup>3</sup> (can differ depending on colour)	1.24 g/cm <sup>3</sup>
Modulus of elasticity	2,300 MPa	2,700 MPa
Service temperature, long-term	170 °C	160 °C
Service temperature, short-term	190 °C	180 °C
Lower service temperature	-50 °C	-50 °C (Exceptions down to -100 °C)

## Identifying characteristics

- Colour translucent, amber coloured, darkening with PPSU on rising glass transition temperature
- Low flammability
- Burns with luminous yellow, sooting flame
- Extinguishes slowly after removing the flame
- Pungent odour
- Dissolves in methylene chloride

## Products / Modifications

### **TECASON P MT coloured (PPSU)**

Special type in a variety of colours for medical technology, tested biocompatibility, suitable for contact with foods

### **TECASON P VF (PPSU)**

Unreinforced basic type, calendered for deep-drawn products, transparent and in opaque colours

### **TECASON P MT XRO coloured (PPSU)**

Special type for use in medical technology, biocompatible, x-ray opaque

### **TECASON S (PSU)**

Unreinforced basic type, compatible for food contact

### **TECASON E GF30 (PES GF)**

non-standard production, preferably for injection moulding, glass fibre reinforced for high strength, electrical components, flame retarded

## Application examples

PPSU is used preferably in medicine in the field of joint prosthetic surgery for adjustment models, for device handles, sterilization and storage containers, food and pharmaceuticals production plants.

PSU for chemical and laboratory equipment, plug components, lamp fittings, electrical engineering, for high-frequency technology, aerial carriers, coil formers, microwave equipment, microelectronics, test adapters.

PES GF is used preferably for injection moulding of high-strength, rigid precision electrical components with flame retardant properties.

## Summary

PES has been superseded by the product development of PPSU, and is only of significance nowadays for the manufacture of special products. The typical characteristic profiles of the three amorphous polysulphone polymers (PSU, PPS, PES) are very similar. The main differences are in their glass transition temperatures and service temperature ranges.

The strength value, toughness and chemical resistance levels of the three differ only in detail. Also in comparison to PEI, certain properties overlap. However, it offers significantly higher mechanical characteristic values (strength, rigidity and hardness) as well as being excellently suited for safety-relevant applications in aviation.

Due to its relatively high moisture absorption, PES frequently demonstrates problematic behaviour during superheated steam sterilization with vacuum phase (crack formation).

Alongside PEEK, PPSU is a highly important plastic for use in medical applications, for instance in the field of devices used in imaging diagnostics, OP equipment and orthopaedic technology for joint replacement.

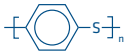

Structural formula PPS

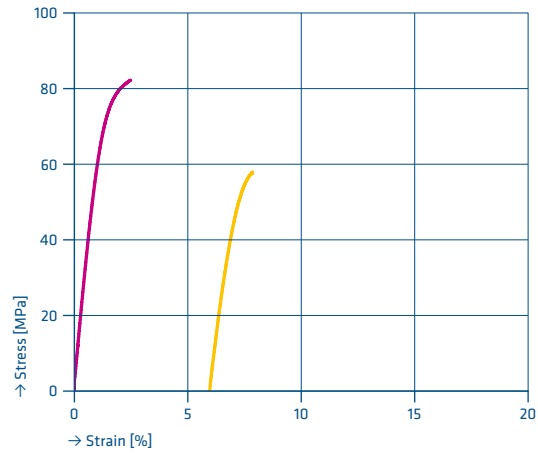

— TECATRON GF40 — TECATRON PVX

# TECATRON

## PPS (DIN designation)

Polyphenylenesulphide (PPS) is a semi-crystalline, high temperature thermoplastic polymer. Its chemical structure makes PPS a highly resistant polymer with high strength and hardness, even in the upper temperature ranges. In addition to low water absorption, it also has good dimensional stability and excellent electrical properties. PPS is chemically very stable even at high temperatures. In the field of semi-finished products, PPS is almost exclusively available in the marketplace in fibre-reinforced form.

## Properties

- High crystallinity
- High density
- High strength, hardness and rigidity
- High thermal stability
- Very high chemical resistance, even at low temperatures
- Excellent solvent resistance
- Hydrolysis-resistant, not sensitive to stress cracking
- Very low moisture absorption
- Minimal thermal expansion
- Highly dimensionally stable in a fibre-reinforced version
- High radiation resistance to gamma and X-rays
- Very good electrical insulation properties
- Low ionic contamination in special types
- Inherently flame resistant, self-extinguishing

## Values

	TECATRON (PPS)	TECATRON GF40 (PPS GF)
T <sub>g</sub>	97 °C	93 °C
Density	1.36 g/cm <sup>3</sup>	1.63 g/cm <sup>3</sup>
Modulus of elasticity	4,100 MPa	6,500 MPa
Service temperature, long-term	230 °C	230 °C
Service temperature, short-term	260 °C	260 °C
Lower service temperature (increasing brittleness)	-20 °C	-20 °C

---

### **Identifying characteristics**

- Colour beige / natural, under the effects of UV quickly develops localized brown patches
- Low flammability
- Sulphurous odour of rotten eggs
- Extinguishes after removing the flame
- Hard, bright sound on impact

---

### **Products / Modifications**

#### **TECATRON (PPS)**

Basic type, only for special applications

#### **TECATRON GF40 (PPS GF)**

Glass fibre reinforced for high strength and rigidity

#### **TECATRON GF40 black (PPS GF)**

Glass fibre reinforced, dyed black, improved UV protection for outdoor applications and colour-stable products

#### **TECATRON PVX (PPS CS CF TF)**

Special type with modified sliding properties to comply with sliding requirements under high temperatures, loads and the effects of chemicals and steam

---

### **Application examples**

Structural components for chemical environments, valves, filter housings, pump and fitting components, pump impellers, sliding components exposed to temperature and chemical influences as well as hot water, roller bearings for continuous driers, electrical components, plugs, housings, core formers, lamp housings, unreinforced special types with low ion contamination for semi-conductor production

---

### **Summary**

The deployment of TECATRON materials frequently offers the optimum compromise where the performance parameters of PA 66 GF30 have reached their limits and a solution using PEEK materials would exceed budgetary restrictions. In the automotive industry, for instance, PPS is frequently used predominantly for applications in the engine compartment where PA 66 GF30 is no longer able to provide adequate characteristics. Alongside the high level of material strength and dimensional stability, another outstanding feature of PPS is its dimensional stability.

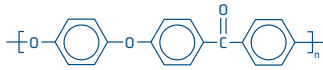

Structural formula PEEK

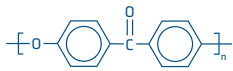

Structural formula PEK

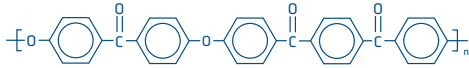

Structural formula PEKEKK

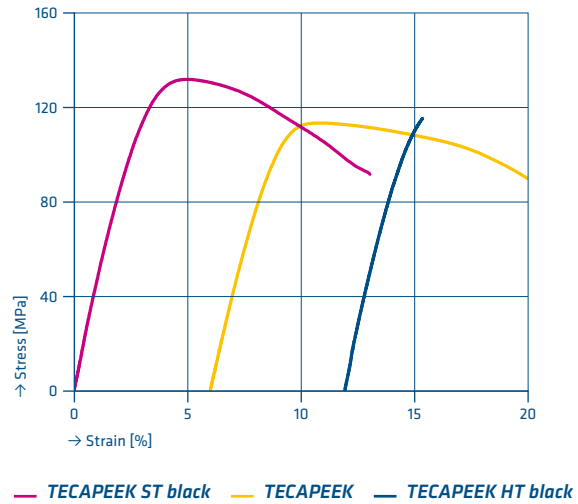

# TECAPEEK

## PAEK (DIN designation)

The group of polyaryletherketones (PAEK) encompasses in the main PEEK, PEK, PEKEKK and PEKK.

The molecular structure of the members of this polymer group differs in terms of the respective number of cohesive ether and ketone groups. Consequently, with an increasing number of ketone groups, underlying distinctions occur with rising glass transition and melting temperatures. Processability by melting becomes increasingly difficult, and is then replaced by pressing methods, which are the preferred option for large-scale semi-finished product dimensions. A typical characteristic of this group of materials, which is classified as part of the thermoplastic high-temperature plastic group, is that its property profile is largely maintained also in high-temperature ranges above 100 °C; Most characteristic values change only moderately. The most important material and the one with the most technical uses is the polyetheretherketone PEEK.

The materials belonging to the polyaryletherketone group are characterized by an unusually complex property profile with a large number of excellent individual characteristics.

## Properties

- Semi-crystalline
- Low density
- High degree of toughness
- High strength, hardness and rigidity
- Low tendency to creep

- Good sliding friction properties, good abrasion resistance
- Very good chemical resistance to a wide range of technical media
- Hydrolysis resistance, tendency to stress crack formation
- High thermal stability
- Unusually high radiation resistance to gamma and X-rays
- Very low moisture absorption
- Minimal thermal expansion
- Good dimensional stability
- Inherently flame resistant, self-extinguishing
- Minimal ion contamination
- Very low outgassing rates in high vacuum
- Minimal, low-toxicity gas development in case of fire

## Values

	TECAPEEK (PEEK)	TECAPEEK HT (PEK)	TECAPEEK ST (PEKEKK)
T <sub>g</sub>	150 °C	160 °C	165 °C
Density	1.31 g/cm <sup>3</sup>	1.31 g/cm <sup>3</sup>	1.32 g/cm <sup>3</sup>
Modulus of elasticity	4,200 MPa	4,600 MPa	4,600 MPa
Service temperature, long-term	260 °C	260 °C	260 °C
Service temperature, short-term	300 °C	300 °C	300 °C
Lower service temperature (Exceptions down to -100 °C, increasing brittleness)	-40 °C	-40 °C	-40 °C

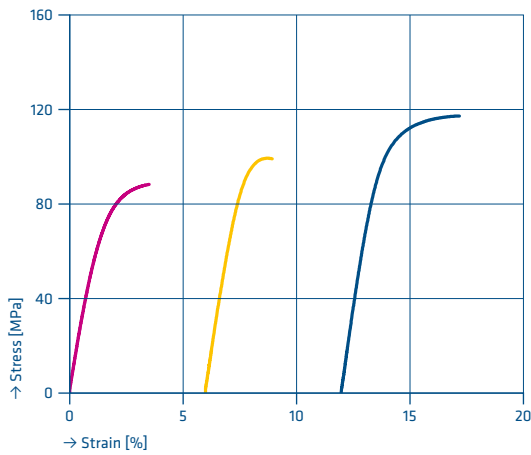

— TECAPEEK PVX — TECAPEEK GF30 — TECAPEEK CF30

### Identifying characteristics: PEEK natural colour

- Colour beige, characteristic
- Low flammability
- Extinguishes after removing the flame
- Minimal sooting
- Extreme hardness and rigidity
- Density significantly  $> 1 \text{ g/cm}^3$ , sinks in water

### Products / Modifications

#### TECAPEEK (PEEK)

Unreinforced basic types

#### TECAPEEK black (PEEK)

Improved UV radiation for outdoor use

#### TECAPEEK luminous red (PEEK)

Signal and warning colour for industrial application, operating elements

#### TECAPEEK CF30 (PEEK CF)

Carbon fibre reinforced for high strength and rigidity, sliding properties

#### TECAPEEK ELS nano (PEEK CNT)

Electrically conductive with CNT

#### TECAPEEK GF30 (PEEK GF)

Glass fibre reinforced for high strength and rigidity

#### TECAPEEK PVX (PEEK CS, CF, TF)

With modified sliding properties for technical sliding applications with high loading capacity

#### TECAPEEK HT black (PEK)

Unreinforced, higher thermal mechanical loading capacity than PEEK

#### TECAPEEK ST black (PEKEKK)

Unreinforced, higher thermal mechanical loading capacity than PEK

#### TECAPEEK CF30 MT (PEEK CF)

Special type, carbon fibre reinforced, for high strength, biocompatible, black

#### TECAPEEK CLASSIX white (PEEK)

Special type for medical technology applications, suitable for 30 days of tissue contact, biocompatible

#### TECAPEEK MT (PEEK)

Natural version for medical technology, biocompatible

#### TECAPEEK MT coloured (PEEK)

Special types in a variety of colours for medical technology, biocompatible

#### TECAPEEK ID blue

(PEEK, detectable filler)

modified for inductive detectability in food and pharmaceutical processes, suitable for food contact

#### TECAPEEK TF10 (PEEK TF)

Sliding properties modified with PTFE, suitable for contact with food

#### TECAPEEK TS (PEEK, mineral)

With mineral filler, high strength and rigidity, toughness, high degree of hardness and low thermal expansion

#### TECATEC PEEK CW50 (PEEK CF)

Reinforced with woven carbon fibre fabric, strength behaviour on the fabric level similar to steel, biocompatible

#### TECATEC PEKK CW60 (PEKK CF)

Reinforced with woven carbon fibre fabric, strength behaviour on the fabric level similar to steel, biocompatible

### Application examples

Polyaryletherketones are a high-performance polymer group, each member of which has an array of unusual properties and behaviours, making this a highly important source of materials for modern technology and industry. TECAPEEK (PEEK) plays an outstanding role among this group.

Sliding components, guide rollers, chain guides in ovens, tank linings, thermoformed parts, various components for food, drinking water, medical, pharmaceutical and biotechnological use, packaging plants, semi-conductor technology and microelectronics, nuclear and x-ray technology, gas and oil exploration and conveying, aerospace applications, gears and engine building

### Summary

Compared to TECAPEEK (PEEK), the melting and glass transition temperatures and strength levels of TECAPEEK HT (PEKEKK) are higher.

Its chemical resistance is tendentially better. The hydrolysis resistance of polyaryletherketones to superheated steam is greater than is the case with high-temperature plastics PI and PAI. Compared to PEI, their alkali resistance at high temperatures is an outstanding feature.

The special materials of the TECATEC family offer extreme mechanical strength and thermal dimensional stability due to the carbon fibre fabric.

The PAEK-based polymer matrix also provides high resistance to superheated steam and chemicals, making TECATEC ideal for use in medical technology applications.

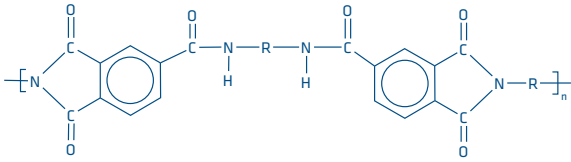

Structural formula PAI

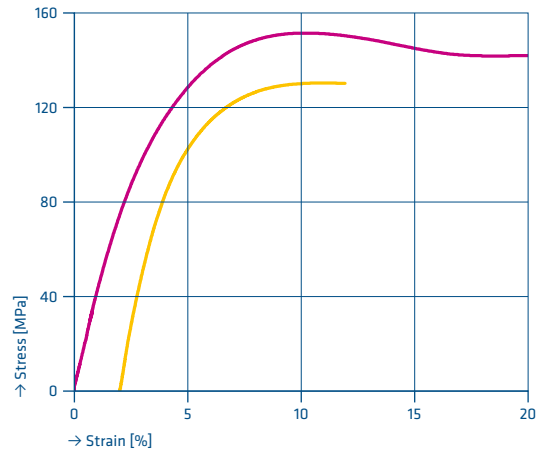

— TECATOR 5013 — TECATOR 5031 PVX

## TECATOR

### PAI (DIN designation)

Polyamidimides (PAI) are amorphous, thermoplastic high-performance polymers characterized by high thermal stability. Their high molecular weight means that these materials cannot be melted, but are thermally destroyed on testing.

PAI belongs to the group of thermoplastic polyimides. These polyimides are characterized by an unusually complex characteristic profile with a number of outstanding characteristics. A high level of toughness, rigidity and creep strength coupled with low thermal expansion ensure good mechanical loading capacity and dimensionally stable components.

Modification with graphite and PTFE produces a highly abrasion-resistant bearing material with minimal friction resistance which remains efficient even in dry running situations.

### Properties

- Amorphous
- High density
- Good sliding friction properties, high abrasion resistance
- High degree of toughness
- Very high strength and hardness
- Very good chemical resistance
- Hydrolysis sensitivity to hot water continuously at temperatures over 100 °C, superheated steam and alkali
- Relatively high moisture absorption impairs dimensional stability
- High thermal stability
- Unusually high radiation resistance to gamma and X-rays
- Inherently flame resistant, self-extinguishing

---

### Values

	<b>TECATOR 5013 (PAI)</b>	<b>TECATOR 5031 PVX (PAI)</b>
T <sub>g</sub>	280 °C	280 °C
Density	1.40 g/cm <sup>3</sup>	1.46 g/cm <sup>3</sup>
Modulus of elasticity	3,800 MPa	5,900 MPa
Service temperature, long-term	250 °C	250 °C
Service temperature, short-term	270 °C	270 °C
Lower service temperature	-150 °C	-150 °C

---

### Identifying characteristics

- Typical colours: Outer skin brown, yellow brown inside
- Low flammability
- Burns with a blue flame with yellow tip
- Minimal or no sooting

---

### Products / Modifications

#### **TECATOR (PAI)**

Basic type, tough, electrically insulating

#### **TECATOR 5031 PVX (PAI CS TF)**

Sliding properties modified with graphite and PTFE additive

#### **TECATOR GF30 (PAI GF)**

High-strength fibre-reinforced type for injection moulding

---

### Application examples

Sliding components, guide rollers, chain guides, sliding bearings, gears, thrust washers (axial sliding bearings) in gear manufacture, balls in hydraulic controls.

Glass fibre-reinforced high-strength dimensionally stable structures used in the aerospace industry, runners, deflection rollers, paper guides in printers, copiers, office machinery.

Plug components and test sockets for chip testing in the microelectronics industry, lamp holders.

---

### Summary

The amide groups have elevated moisture absorption and also provide very good toughness, but demonstrate dimensional changes and limited hydrolysis resistance.

For use in the higher temperature range, preliminary drying is advisable in order to prevent hydrolytical damage. Components machined as semi-finished products undergo thermal treatment at the end of the polymerization process, which simultaneously lends them improved abrasion resistance on running surfaces in conjunction with oxidation of the surface.



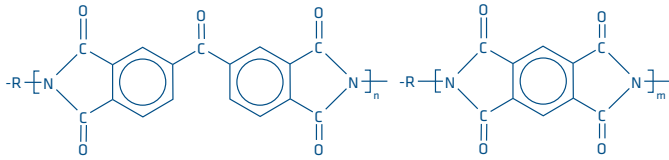

Structural formula PI

DMA 3-point bending test, 1Hz, 2K/min

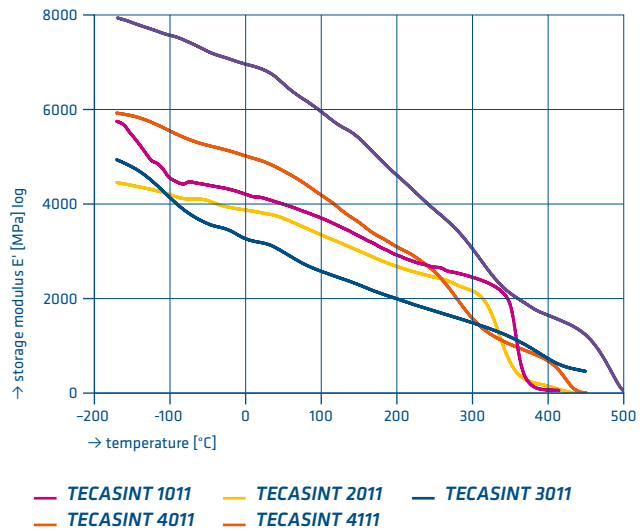

# TECASINT

## PI (DIN designation)

Polyimides (PI) are produced by polycondensation. They are non-fusible due to the high amount of ring-shaped, mostly aromatic chain links and high molecular weights. The manufacturing of semi-finished products or direct-forming parts is therefore done exclusively by sintering techniques.

The materials belonging to the polyimide group are characterised by an unusually complex property profile with a large number of excellent individual characteristics and so take up a position at the tip of the material pyramid.

## Properties

- Non-melting high-temperature polyimide
- High strength, modulus and rigidity, also in the high temperature range
- High compressive strength and creep resistance
- High purity, low outgassing in vacuum conditions
- Good chemical resistance
- Good thermal and electrical insulation
- High radiation resistance
- Inherently flame resistant
- High density
- Hydrolysis sensitivity to hot water >100 °C and superheated steam

## Values

	TECASINT 2011 (PI)	TECASINT 4011 (PI)	TECASINT 4111 (PI)
T <sub>g</sub> [°C]	370	260	n.a.
Density [g/cm <sup>3</sup> ]	1.38	1.41	1.46
Modulus of elasticity [MPa]	3,700	4,000	7,000
Service temperature, long-term [°C]	300	300	300
Service temperature, short-term [°C]	>350	>350	>400
Lower service temperature [°C]	-270	-270	-270

## Identifying characteristics

- Low flammability, does not burn
- Density >1 g/cm<sup>3</sup>, sinks in water
- Very hard to tough-soft, depending on type
- Hard / muffled sound on impact

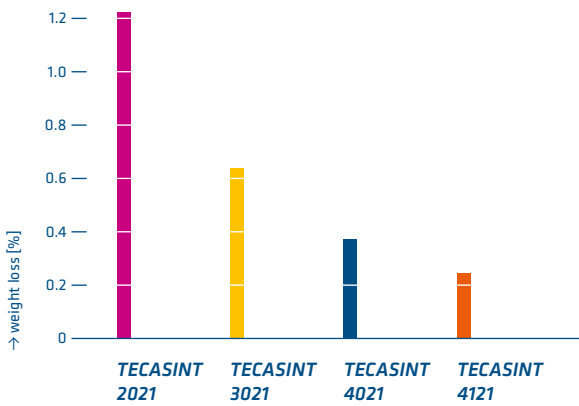

## Products

### TECASINT 1000

Highest modulus.  
Highest rigidity and hardness.  
Previous designation SINTIMID.

### TECASINT 2000

Very high modulus, high rigidity and hardness.  
Compared to TECASINT 1000, significantly reduced moisture absorption.  
Higher toughness and improved machining capability.  
Ideally suited for direct forming components.

### TECASINT 4000

Compared to the other TECASINT materials, TECASINT 4000 is characterized by the following properties:  
Minimal water absorption.  
Highest stability against oxidation in air.  
Low friction.

Optimum chemical resistance.  
HDT up to 470 °C.  
Different types available with high fracture strain and toughness or with high flexural modulus.

### TECASINT 5000

Non-melting high-temperature polyamidimide (PAI).  
Extremely good dimensional stability and load capacity up to 300 °C.

### TECASINT 8000

Matrix of PTFE reinforced with PI powder.  
Reduced creep under load.  
Excellent sliding and friction properties.  
Ideally suited for soft mating partners (stainless steel, aluminium, brass, bronze).  
Extreme chemical resistance and simple machining properties.

## Application examples

Guide rollers, chain guides in process ovens, hot glass handling, special types without ion contamination for the semi-conductor industry, sliding parts with high thermal mechanical load capacity for use in engines, gears, aircraft turbines, thermal-electrical insulators in particle accelerators. Used in many cases as a substitute for metal (for weight reasons). Used for various components for which PEEK would be easily usable given a less stringent requirement profile with temperature as the main criterion, as well as applications with stringent requirements of durability, safety and reliability.

Indispensable material group in the aerospace industry, glass industry, cryogenics and vacuum technology, research and development in general, high and low-temperature physics, fundamental research on elementary particles, fundamental nuclear technology.

## Modifications

### Unfilled

Maximum strength and elongation.  
Highest modulus.  
Minimal thermal and electrical conductivity.  
High purity.  
Low outgassing in accordance with ESA regulation ECSS-Q-70-20.

### + 30 % glass fibres

Reduced thermal elongation.  
High thermal-mechanical load properties.  
Good electrical insulation.

### + 15 % graphite

Enhanced wear resistance and thermal ageing.  
Self lubricating, for lubricated and dry applications.

### + 40 % graphite

Reduced thermal elongation.  
Maximum creep strength and resistance to thermal ageing.  
Improved self-lubrication.  
Reduced strength.

### + 15 % graphite

#### + 10 % PTFE

Extremely low static friction and low coefficient of friction due to PTFE modification.  
Good properties also in dry running conditions due to self lubrication.  
For applications involving low friction and wear characteristics at medium temperatures and loads (< 200 °C).

### + 15 % MoS<sub>2</sub>

Best friction and abrasion properties in vacuum.  
Frequently used in aerospace applications, in vacuum or in inert gases (techn. dry).  
Low outgassing in accordance with ESA regulation ECSS-Q-70-20.

### SD

Static dissipative / antistatic, permanently migration free.  
Surface resistance 10<sup>9-11</sup> or 10<sup>7-9</sup> Ω.  
For explosion-proof equipment and in semi-conductor technology (test sockets).

## Summary

The use of polyimides is frequently either the only available solution or provides an economical alternative to metals, ceramics or other engineering plastics. Several different material settings in each of the typical application-oriented groups cover a wide range of user requirements:

- Sliding types hard / soft
- Statically dissipating types
- Electrically insulating types
- High-strength glass fibre reinforced types
- High-strength unreinforced types





*In order to determine correct material for an application, it is important to note the material characteristics and the requirement profile in detail.*

The greater the amount of data available on the application conditions, the more precisely the suitable material can be determined. The following section explains the main product characteristics and tests. We have also compared the most important materials in order to simplify the comparison.

*Properties*

# Modifications / additives

**Thermoplastics can be modified over an extremely wide spectrum by the selective integration of additives and fillers. This allows the characteristics of a material to be adapted for a specific area of application. The most common modifications in the field of engineering and high-temperature plastics are:**

## Reinforcing fibres

### Glass fibres

Glass fibres are primarily used to increase strength values.

- Increased tensile strength, compressive strength and rigidity
- Improved creep strength
- Increased thermal dimensional stability
- Reduction of thermal expansion and shrinkage
- Reduction of toughness and consequently breaking strength and impact strength

*Please note:*

Glass fibres have an abrasive effect. For this reason, glass fibre-reinforced materials are

- less suited for sliding friction applications (high abrasion of the sliding partner) and when processed bring about increased levels of tool wear (shortened service life)

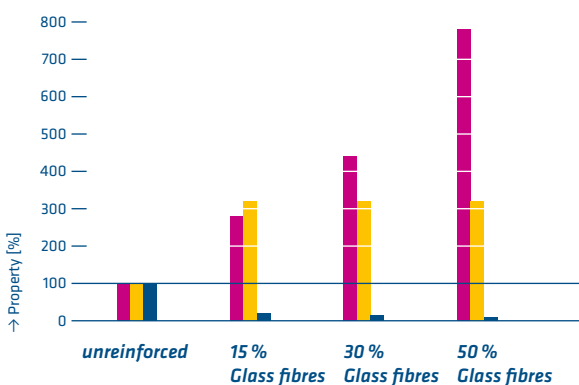

- Modulus of elasticity
- Heat deflection temperature
- Elongation at break

Tests performed on injection moulded test specimens

### Carbon fibres

Carbon fibres have a similar effect to glass fibres, but

- carbon fibres provide a better weight-to-strength ratio (lower density with comparable increase in strength)
- carbon fibres are not as abrasive as glass fibres, and are consequently suitable for sliding friction applications
- the influence of carbon fibres on electrical properties can be disregarded (including undefined electrical conductivity)
- carbon fibres are more expensive than glass fibres

### Additional reinforcing fibres

- Aramid fibres
  - Mineral fibres
- can be offered as non-standard options

## Friction-reducing additives

### PTFE

Under compressive stress, abraded material from PTFE-filled plastics forms a fine polymer film with sliding properties on the sliding surface.

- Typically pronounced anti-adhesive behaviour
- Effective avoidance of stick-slip effect

### UHMW-PE

Demonstrates similar effects to PTFE in a less pronounced form.

### Silicone oils

Special oils which migrate to the surface and form a thin lubricant film on the surface.

### Graphite

Graphite is pure carbon, which in finely ground form demonstrates a marked lubricant effect. By working graphite evenly into a plastic, the coefficient of friction is reduced. The lubricant effect of graphite is particularly pronounced in humid environments.

### Molybdenum sulphide (MoS<sub>2</sub>)

Molybdenum sulphide is used predominantly as a nucleating agent, and forms an even finely crystalline structure even when added only in small quantities. Consequently this additive enhances abrasion resistance and reduces friction.

---

### Fillers

Fillers generally offer no or only minimal technical benefits and serve primarily to reduce costs or weight: Chalk, talcum, ceramic, hollow glass spheres.

---

### Other additives

#### Barium sulphate

This is added to render thermoplastics opaque to x-rays. It ensures that the materials are visible during medical x-ray applications.

#### Flame retardants

These can be added to certain materials in order to reduce their combustibility. The self-extinguishing property of this material is a fundamental requirement in sectors such as aviation and the railways.

#### Impact toughness modifiers

These are added to hard brittle materials to increase their impact toughness.

### Conductivity-influencing additives

Fundamentally, thermoplastics are electrical insulators, but can be modified to provide electrical conduction or anti-static properties by the addition of antistatics, conductive carbon black or carbon nanotubes.

### Colour pigments

By integrating pigments and dyes into engineering plastics, it is possible to create customized colour effects; The selection of pigments for high-temperature plastics is limited by the high processing temperatures.

---

### General

It is important to bear in mind that the addition of any additive has multiple effects; Alongside the positive effect on a key characteristic, other characteristics can be negatively influenced by an additive.

The Ensinger product portfolio offers a number of modified materials from stock. Alongside these materials, customer-specific requirements can also be met by production to customer order.

Additive	Strength	Elongation	Sliding friction behaviour	Toughness	Dimensional stability	Flame resistance
Reinforcement fibres	↑↑	↓	↓↑	↘	↓↑	↗
Friction-reducing additives	↘	↘	↑↑	↘	↘	—
Impact toughness modifiers	↘	↑	↘	↑↑	↘	↘
Flame retardant properties	↘	↓	↘	↓	↗	↑↑

---

# Thermal properties

## Characteristic temperatures

### Glass transition temperature

The glass transition temperature  $T_g$  is the temperature at which polymers change from a hard elastic and brittle state to a flexible rubbery elastic state. A distinction must be made here between amorphous and partially crystalline thermoplastics.

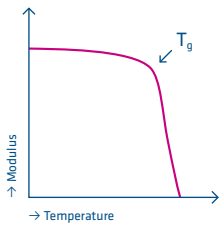

**amorphous**

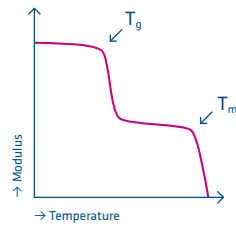

**semi-crystalline**

An amorphous material can be subjected to mechanical wear above the  $T_g$ , as here its mechanical strength decreases sharply. Partially crystalline materials, in contrast, still demonstrate a certain mechanical strength beyond the  $T_g$  due to their crystalline areas, and are therefore particularly well suited for components exposed to mechanical stress.

### Melting temperature

The melting temperature  $T_m$  is the temperature at which a material melts, i.e. changes from the solid to the fluid aggregate state and its crystalline structures break down.

## Service temperatures

### Long-term service temperature

The long-term service temperature is defined as the maximum temperature at which a plastic has lost no more than 50% of its initial properties after 20,000 hours of storage in hot air (in accordance with IEC 216).

### Short-term service temperature

The short-term service temperature is the short-term peak temperature which the plastic can tolerate over a short period (from minutes to occasionally hours) taking into consideration the stress level and duration, without sustaining damage.

The maximum service temperature is dependent upon the following factors:

- Duration of exposure to temperature
- Maximum admissible deformation
- Degradation of strength characteristics due to thermal oxidation
- Ambient conditions

### Negative service temperatures

The service temperature in the negative temperature range is not precisely defined and depends largely on different characteristics and ambient conditions:

- Toughness / brittleness of a material
- Modification: materials with reinforcement fibres tend to demonstrate hard-brittle behaviour
- Temperature
- Duration of load
- Type of load (e.g. impact or vibration load)



**Service temperatures [°C]**

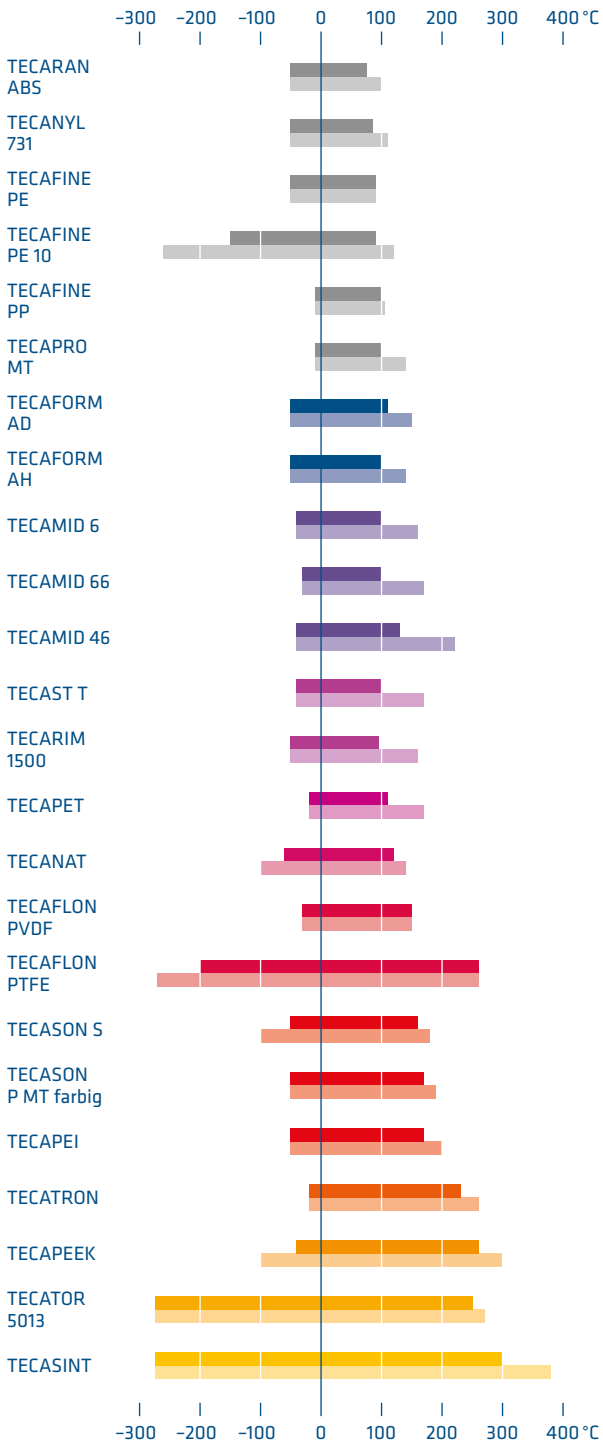

Negative application temperature ← → Service temperature  
 long-term    long-term  
 short-term    short-term

**Glass transition temperature [°C]**

**Melting temperature [°C]**

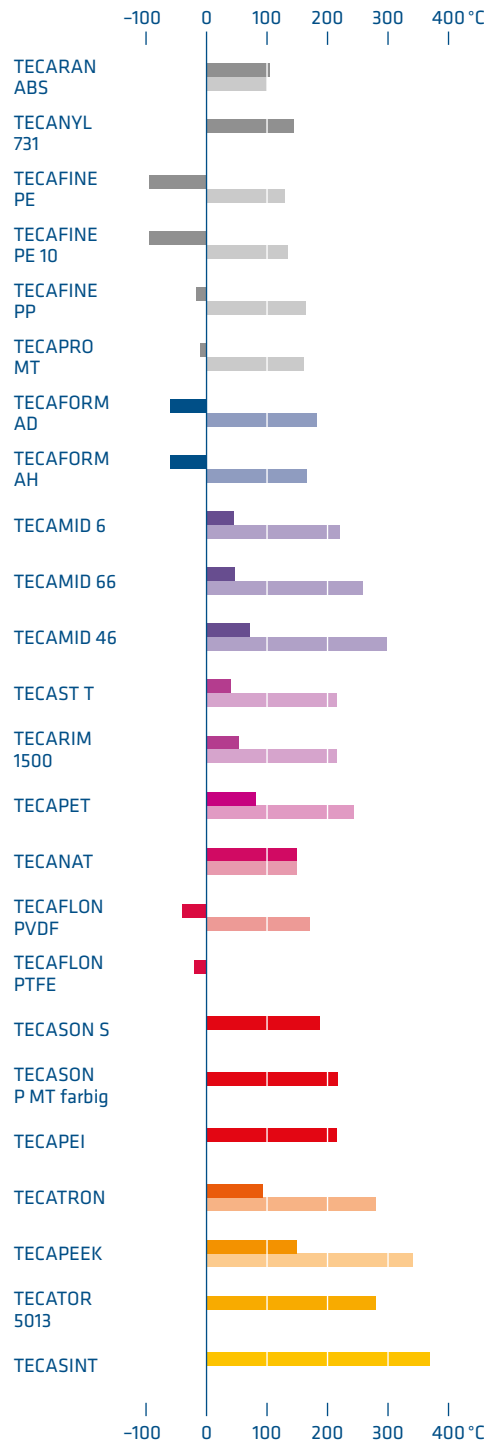

■ Glass transition temperature  
 ■ Melting temperature

## Other thermal specifications

### Thermal dimensional stability

Thermal dimensional stability is a measure of the temperature load capacity of plastics. This is determined by subjecting a material to bending stress under a defined increase in temperature. The temperature level at a defined elongation is the measure of thermal dimensional stability. The thermal dimensional stability cannot be used directly to characterize a material, but is used rather to make a relative comparison between different materials.

When specifying thermal dimensional stability, the product's manufacturing form and the test specimen must be taken into consideration. Measurements have shown that data determined by measuring test specimens milled from semi-finished products deviate from the results gained from injection moulded test specimens.

These differences are explained by the

- Different production techniques
- Differences in the polymer structure
- Manufacturing influence of the test specimen (machining versus injection moulding)

### Coefficient of linear thermal expansion

The coefficient of linear thermal expansion specifies the extent of a change in the length of a material due to rising or falling temperature.

Due to their chemical structure, plastics generally demonstrate a significantly higher coefficient of linear thermal expansion than metals. This must be borne in mind in the event of

- Components with narrow tolerances
- High temperature fluctuations
- Composites with metal

The coefficient of linear thermal expansion of plastics can be significantly reduced by adding reinforcing fibres. In this way, values in the range of aluminium can be achieved.

## Thermal dimensional stability, HDT/A [°C]

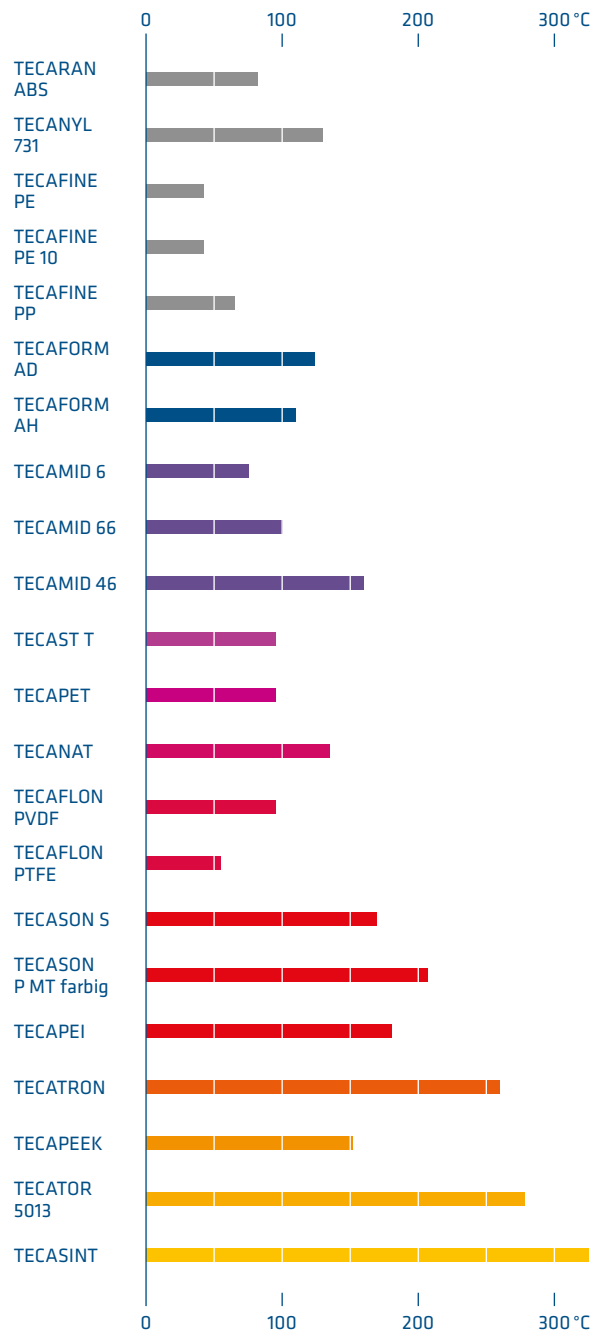

tested on injection moulded test specimens

**Coefficient of linear thermal expansion, longitudinal  
CLTE [ $10^{-5} 1/K$ ]**

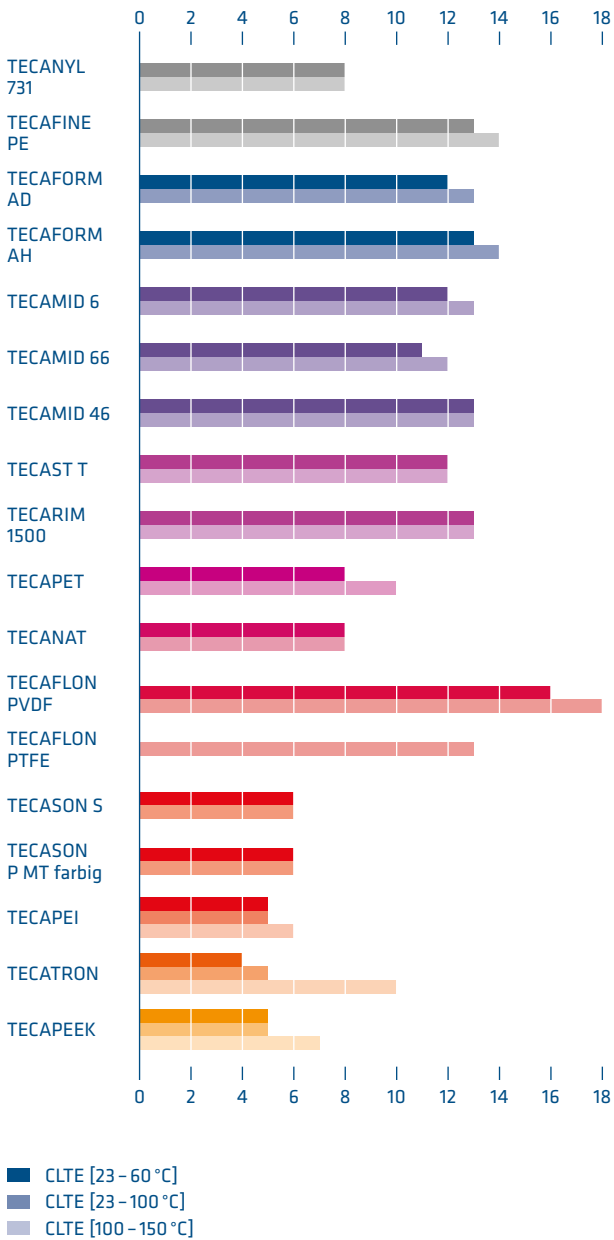

**Coefficient of linear thermal expansion versus  
long-term service temperature**

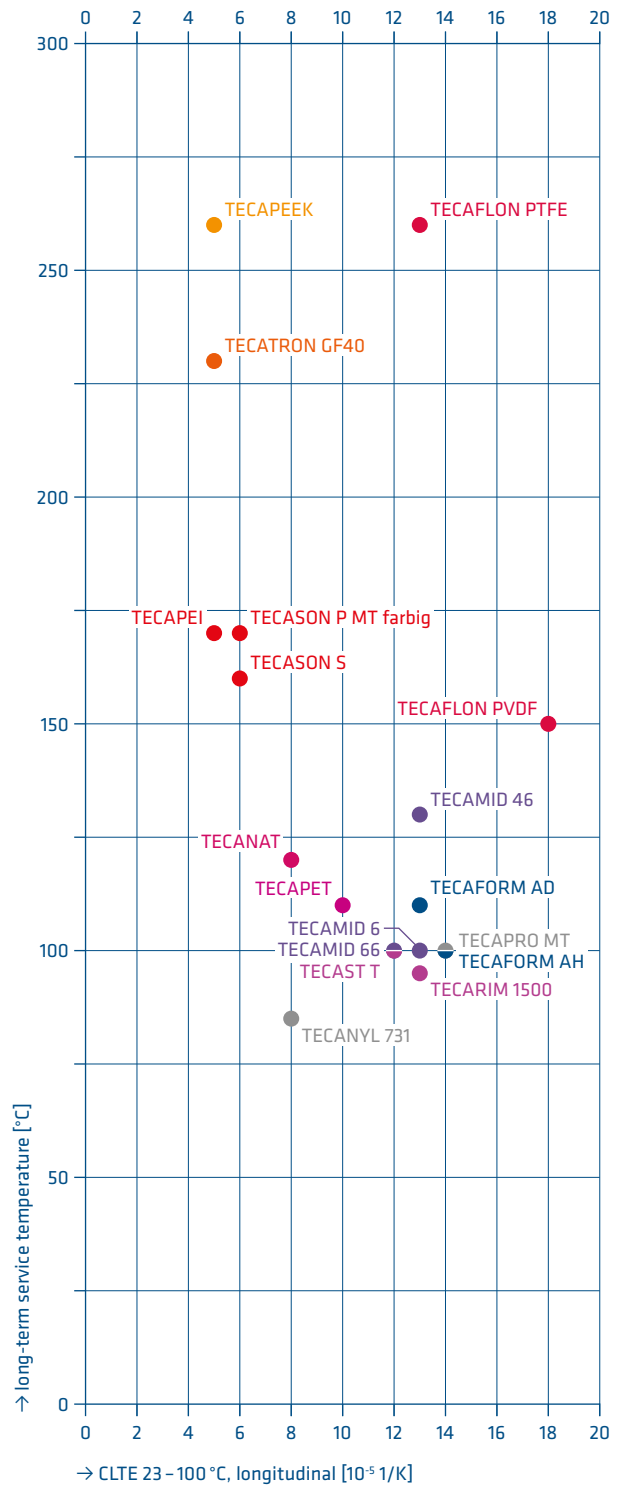

# Mechanical properties

Where plastic components are designed to withstand stress, the mechanical characteristics of a material have a particularly important role to play. The fundamental mechanical material properties include

- *Strength: dimension for the resistance of a material to external stress*
- *Formability: the capacity of a material to become deformed under external stress*
- *Rigidity: dimension for the resistance of a material to deformation*
- *Toughness: dimension for the energy absorption capacity of a material under external stress*

- S Strength
- F Formability
- R Rigidity
- T Toughness

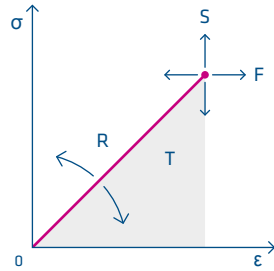

Source: J. Kunz, FHNW

- *Tensile strength at yield  $\sigma_s$*  is the tensile stress at which the slope of the change of force versus length curve (see graph) equals zero for the first time.
- *Elongation  $\epsilon$*  is the change in length  $\Delta L$  in relation to the original length  $L_0$  of the specimen at any point during testing. The elongation at maximum force is described as  $\epsilon_B$ , elongation at break as  $\epsilon_R$ , tensile strength at yield as  $\epsilon_s$ .
- *Modulus of elasticity E*: A linear relationship can only be observed in the lower range of the stress-strain diagram for plastics. In this range Hooke's law applies, which says that the ratio of the stress and strain (modulus of elasticity) is constant.  $E = \sigma / \epsilon$  in [MPa].

Based on the bending, compression and impact toughness test, additional test methods are available for characterizing materials and different load cases.

However, for the sound design of a component, the relevant application conditions must also be taken into consideration: Because of their macromolecular structure, the mechanical properties of plastics depend heavily on the ambient conditions such as temperature, exposure period, type and velocity of loading and moisture content.

These material characteristics are generally determined by briefly applying tensile load in one direction with a tensile test (for example in accordance with DIN EN ISO 527):

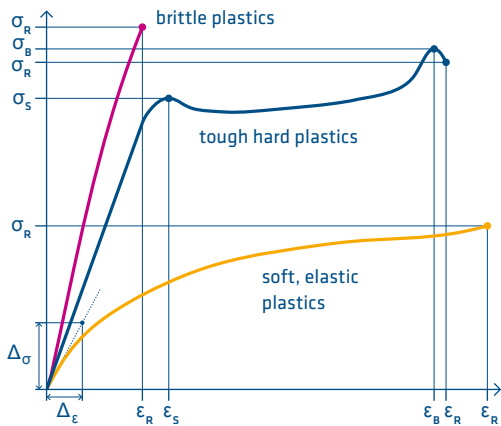

- $\sigma_B$  Ultra-high tension
- $\sigma_R$  Tensile strength at break
- $\sigma_s$  Tensile strength at yield
- $\epsilon_B$  Elongation under ultra-high tension
- $\epsilon_R$  Elongation at break
- $\epsilon_s$  Elongation at yield

- *Tensile stress  $\sigma$*  is the tensile force at the smallest measured starting cross-section of the test specimen at any optional point in time during the test.
- *Tensile strength  $\sigma_B$*  is the tensile stress at maximum force.
- *Tensile stress at break  $\sigma_R$*  is the tensile stress at the moment of break.

## Influences on forming behaviour

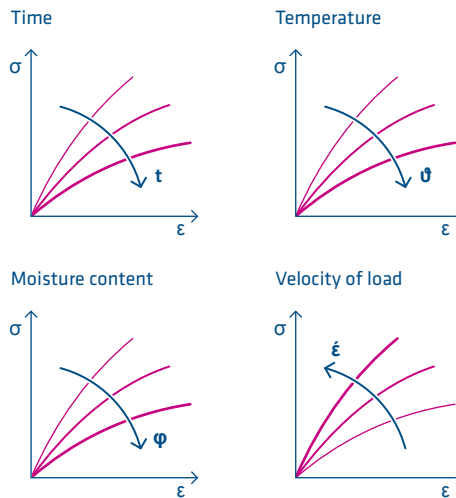

### Influence of time on mechanical characteristics

As mentioned above, the mechanical behaviour of plastics depends on the progress of load application over time. Consequently, for complete characterization, long-term (static) tests also have to be performed alongside short-term (quasi-static) tests, as well as dynamic fatigue tests (with periodic application of load) and impact tests (abrupt application of load).

In terms of deformation behaviour, three types of deformation overlap here:

- Elastic deformation (reversible deformation)
- Viscoelastic deformation (delayed, reversible deformation)
- Plastic deformation (irreversible deformation)

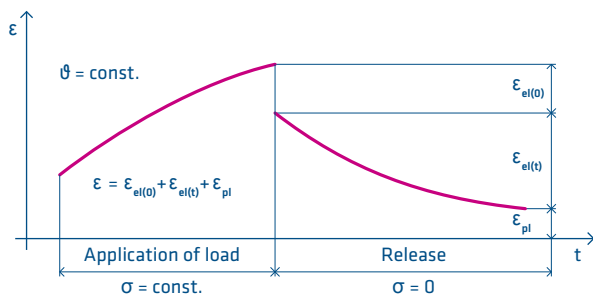

### Deformation of plastics under constant load and after release of load

In this context, viscoelastic deformation merits particular attention. Here, a change of the macromolecular structure takes place. This change follows the application of load with a time delay and is highly temperature dependent. Depending on the progress of load application, the following processes are characteristic of viscoelastic deformation:

- *Retardation*: Increase in deformation over time under constant load
- *Relaxation*: Decrease in tension over time under constant load
- *Restitution*: Decrease in deformation over time after release of load

This time-dependent deformation behaviour is illustrated in time-to-rupture diagrams, creep diagrams, isochronous stress-strain diagrams and creep modulus diagrams. Taken in this context, component designs should not be carried out solely on the basis of single-point characteristic values taken from short-term tests. All application conditions must always be taken into account in the calculation in order to prevent design errors.

### Modulus of elasticity [MPa]

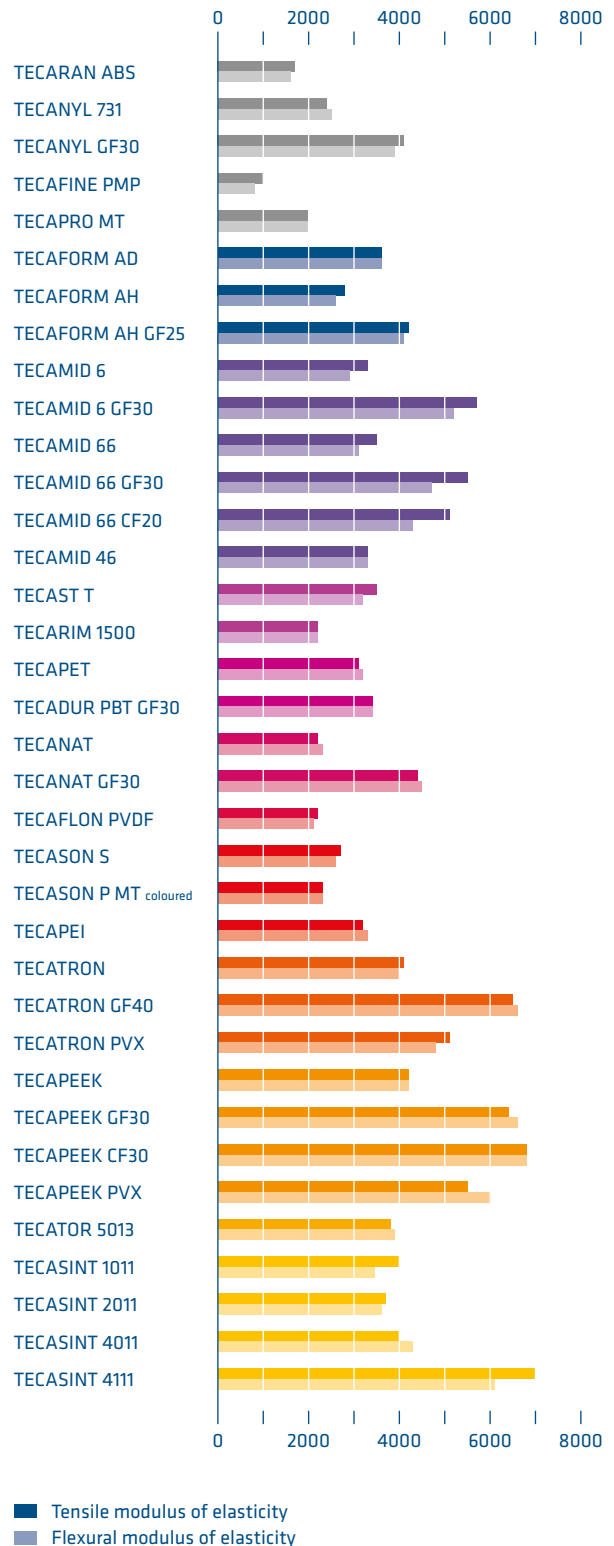

**Strength / Stress [MPa]**

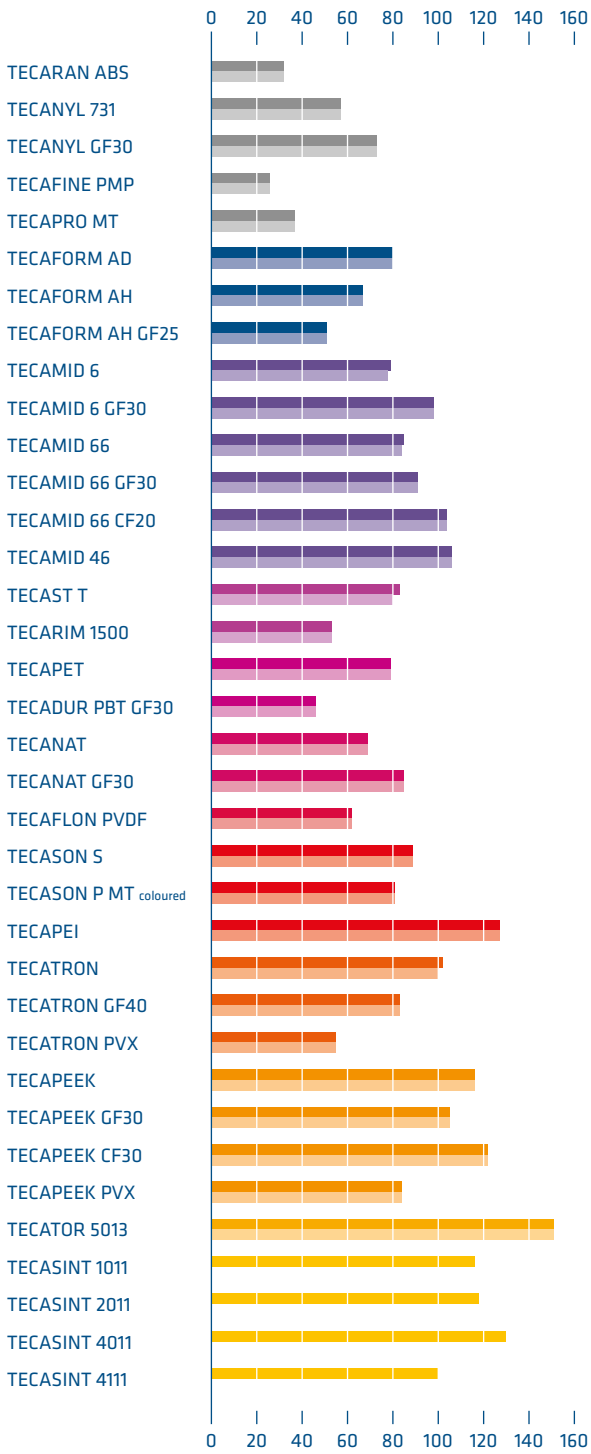

■ Tensile strength  
■ Tensile strength at yield

**Strain [%]**

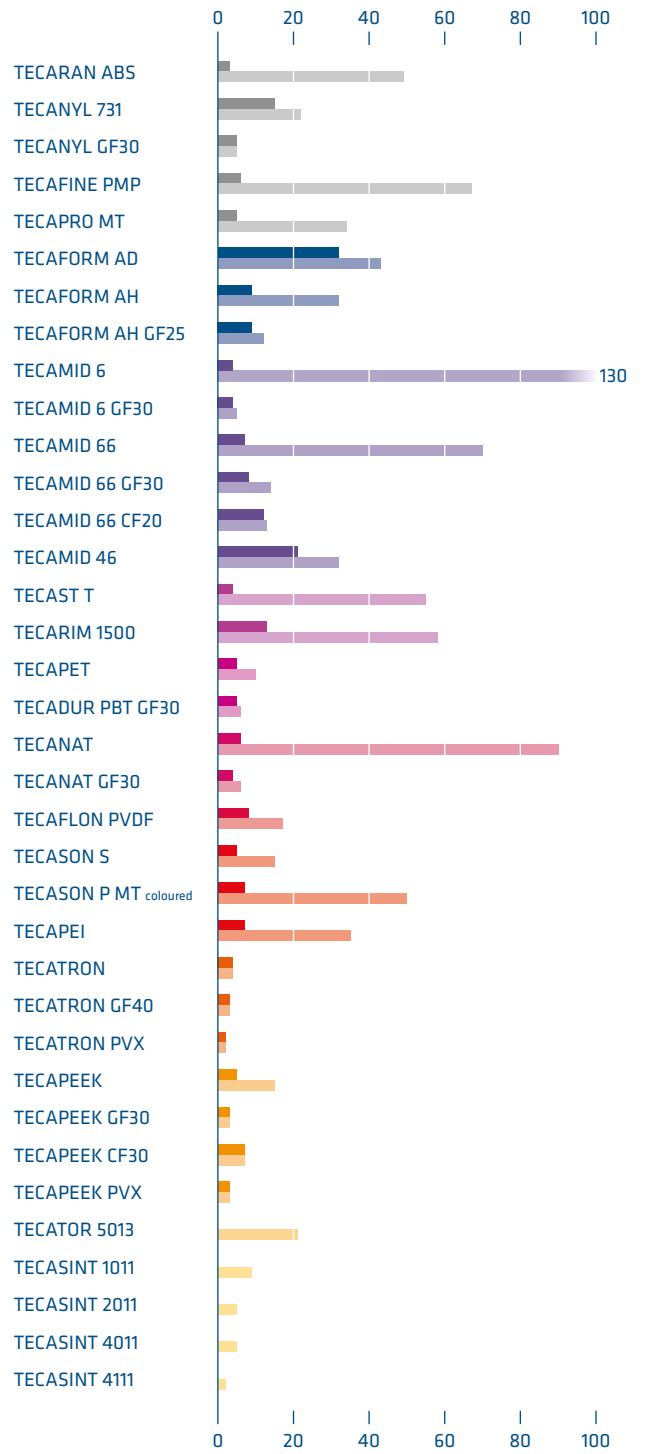

■ Elongation at yield  
■ Tensile elongation at break

**Compressive strength [MPa]**

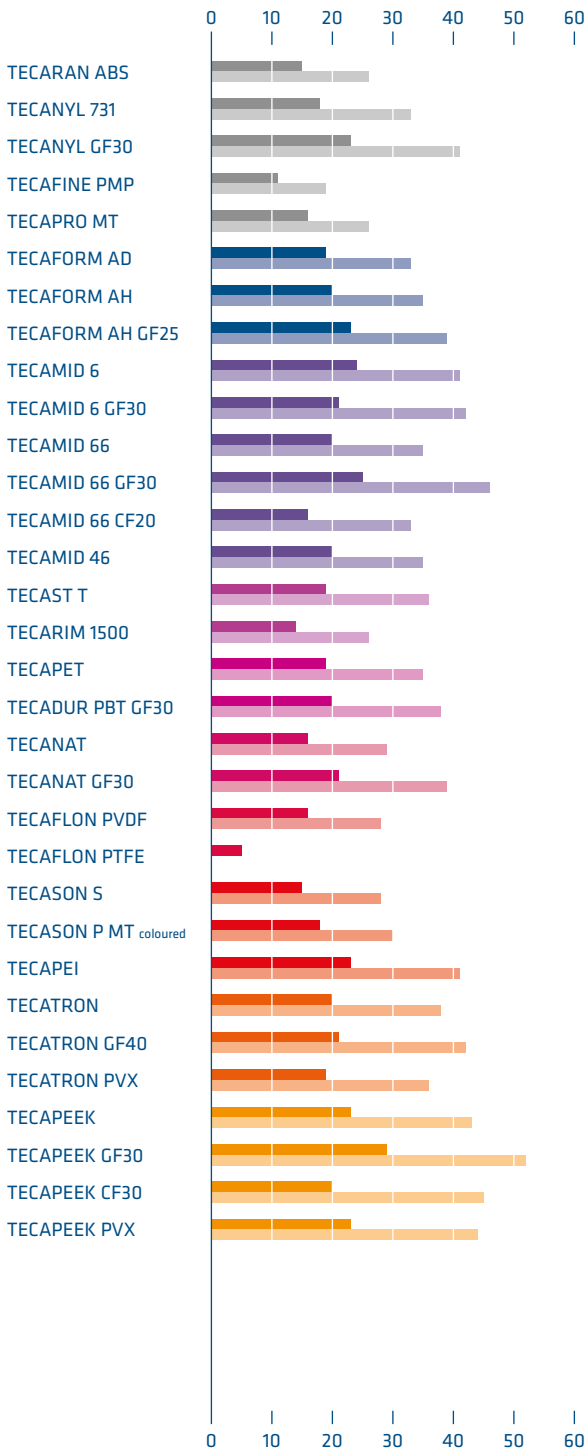

■ Compressive strength 1%  
 ■ Compressive strength 2%

**Ball impression hardness [MPa]**

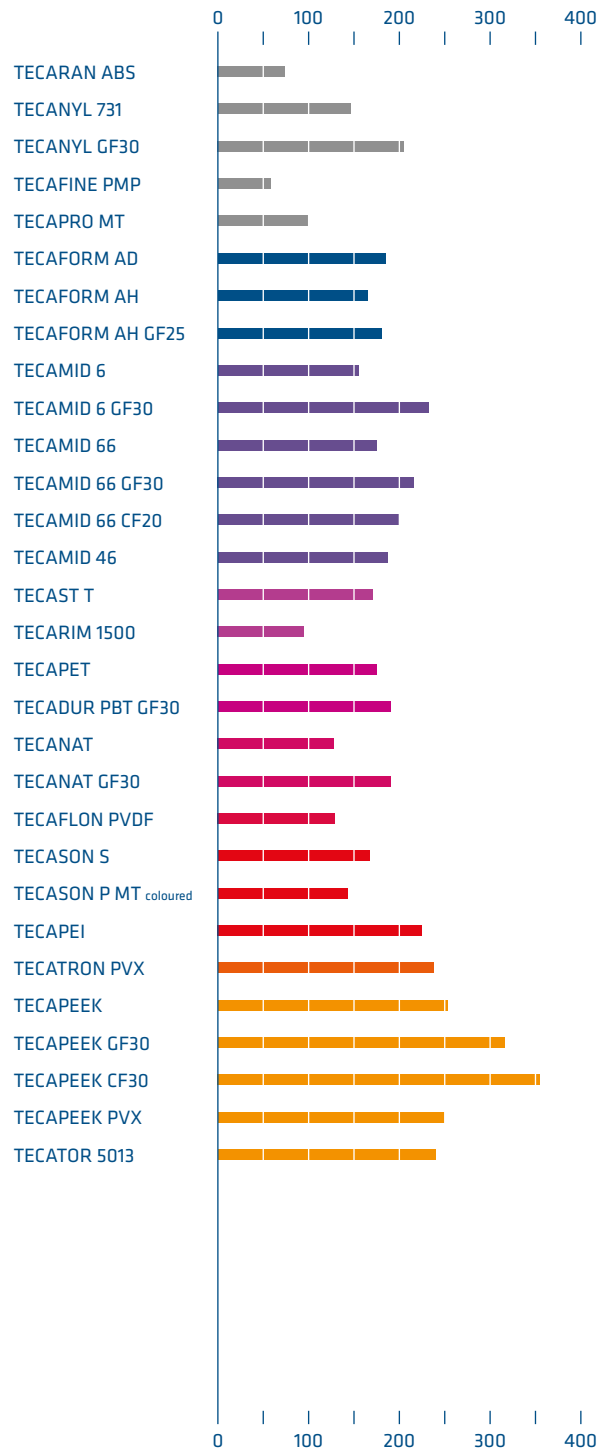

# The influence of processing on test results

The macroscopic characteristics of thermoplastics depend heavily on the relevant processing method used. Because of the higher shear rates typical of the processing method, injection moulded components demonstrate a far more pronounced orientation of macromolecules and any additives in the filling direction than, for instance, semi-finished extruded products which are exposed to rather lower shear rates. Special additives with a high aspect ratio (such as glass or carbon fibres) tend to align themselves predominantly in the direction of flow at higher shear rates. The anisotropy which occurs as a result brings about higher strengths in tensile testing, as here the direction of flow corresponds to the direction of testing.

The thermal prior history of a thermoplastic also exerts a considerable influence on the relevant characteristic values. The cooling process of injection moulded components tends to be faster than for extruded semi-finished products. Consequently there is a noticeable difference in the degree of crystallinity, particularly in the partially crystalline plastics.

In the same way as processing methods, the shapes of semi-finished products (rods, plates, tubes) and their different dimensions (diameter and thickness) also exert an influence on the macroscopic properties and determined characteristic values.

The table below provides a schematic overview of the influence exerted by the different processing methods on typical characteristics.

To allow a comparison of the different test results in this context, DIN EN 15 860 "Thermoplastic semi-finished products" stipulates that test specimens must be taken from rods with a diameter of 40–60 mm as follows:



**Test specimen made of an extruded and machined semi-finished product**  
Chaotic alignment of fibres and macromolecules



**Injection moulded test specimen**  
Alignment of fibres and macromolecules in the direction of testing (parallel to the direction of flow)

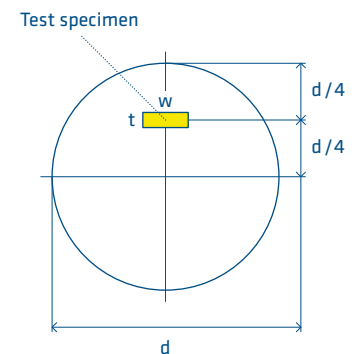

## Tendential influence of processing on characteristic values

	unreinforced thermoplastics		fibre-reinforced thermoplastics	
	Injection moulding	Extrusion	Injection moulding	Extrusion
<b>Tensile strength</b>	↓	↑	↑	↓
<b>Modulus of elasticity</b>	↓	↑	↑	↓
<b>Tensile elongation at break</b>	↑	↓	↓	↑



# Tribological characteristics

Generally speaking, plastics are very good sliding materials with a low coefficient of friction. Conversely, their abrasion resistance is also high under dry running conditions. In a similar way to the mechanical characteristics, tribological characteristics depend heavily on ambient conditions, in other words on the sliding system. Load, sliding speed and type of movement (oscillating, rotating etc.) exert a considerable influence here. In addition, the material characteristics of the sliding partner and its surface properties also exert an influence on the sliding properties of the system.

For example the rough surfaces of harder sliding partners (steel) are more likely to cause wear in softer sliding partners. Also where a combination of high sliding speeds and high pressing forces are at work, the sliding partners are exposed to high levels of stress.

Given these circumstances, tribological variables (such as the coefficient of friction and abrasion) must always be considered in the light of the test system used. Typical measurement methods such as ball prism and pin-on-disc testing are described in ISO 7148. However, when performing service life calculations and similar, application-specific tests should be carried out.

The following diagram is designed to illustrate the dependency of friction coefficients on load and sliding velocity under different sliding conditions using the example of TECAFORM AD (POM-H):

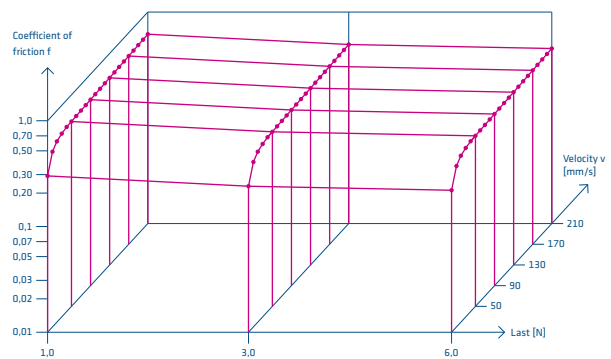

**Ball-prism test under different load stages and different sliding speeds with TECAFORM AD (POM-H)**

## Tribological system according to H. Czichos

Collective of tribological loads	Tribological test system	Tribological measurement variables
Movement form	<b>a</b> Body	Friction force $F_R$
Movement sequence	<b>b</b> Counter-body	Coefficient of friction $\mu = F_R / F_S$
Load $F_S$	<b>c</b> Intermediate film	Contribution to abrasion $S$
Velocity $v$	<b>d</b> Ambient medium	Friction temperature $T_R$
Temperature $T$		Electrical contact resistance $R_U$
Exposure period $t$		Surface variables: Surface roughness Surface composition

Source: Czichos, H. - The principles of system analysis and their application to tribology ASLE Trans. 17 (1974), p. 300 / 306

### Coefficient of friction

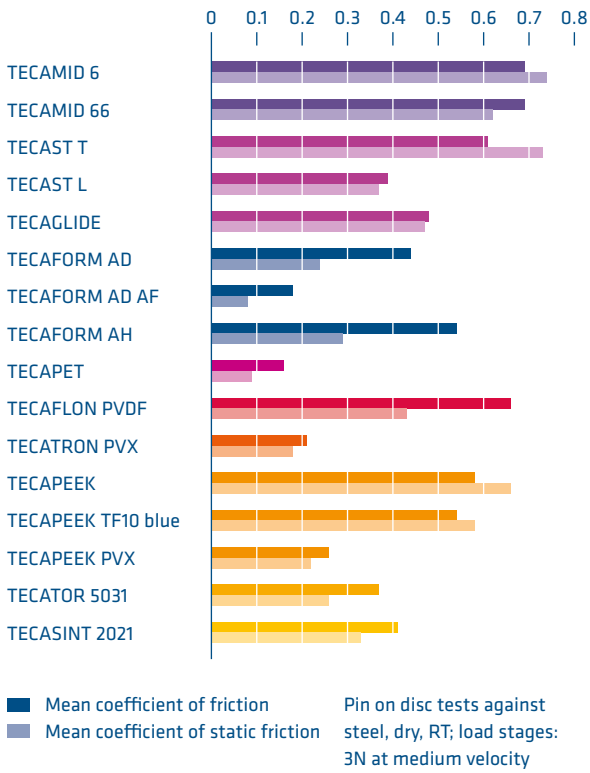

### Abrasion indicators

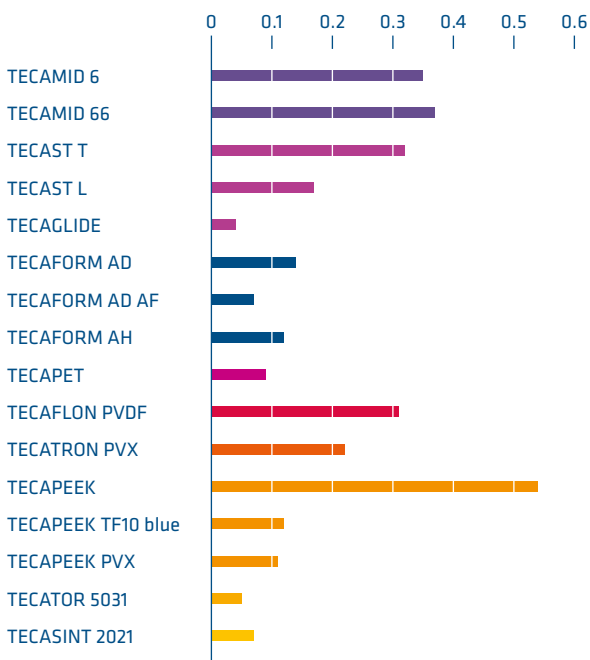

Rotating ball prism against steel, dry, RT,  
load stage: 30N over 100h at medium velocity

### Coefficient of friction versus abrasion

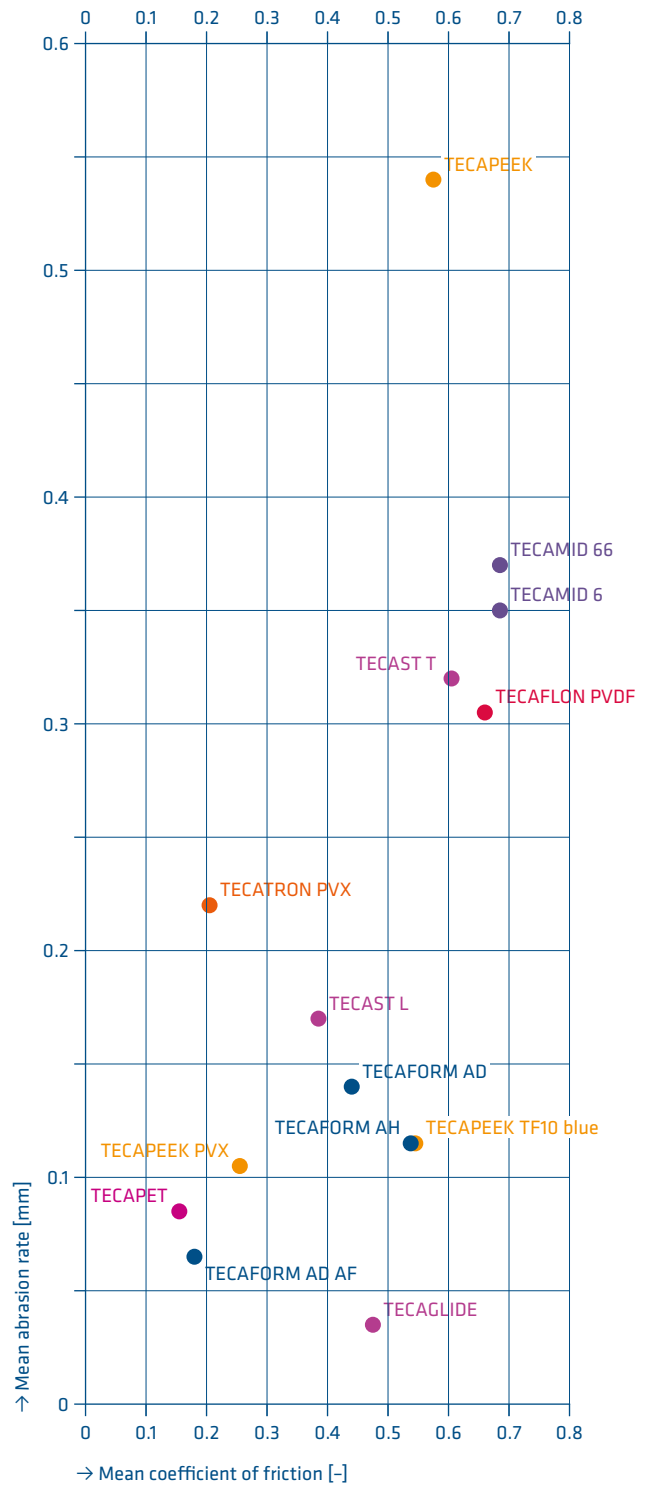

# Electrical properties

---

## Surface resistance

The specific surface resistance describes the resistance that a material exerts against the flow of electricity at the surface. This is expressed by the ratio of applied voltage (in Volts) and the created current (in Amperes) with the aid of Ohm's law. Consequently the unit used to describe specific surface resistance is Ohm ( $1 \Omega = 1 \text{ V/A}$ ).

For measurement, a standardized set-up must be used, as the specific surface resistance depends on different factors.

- Material
- Humidity
- Surface contamination
- Measurement set-up

It is also impossible to prevent volume resistivity from entering the equation to an indeterminable degree when measuring surface resistance.

---

## Specific volume resistivity

The specific volume resistivity describes the electrical resistance of a homogeneous material to the flow of current through the specimen. As the volume resistivity of many materials follows Ohm's law, it is independent of the applied voltage and can be specified proportionally to the length or conversely proportionally to the cross-section of the measured specimen. The unit of specific volume resistivity is consequently  $\Omega \text{ cm}$ .

---

## Dielectric strength

Dielectric strength is the resistance of insulating materials to high voltage. The characteristic value is the quotient of the voltage level and the test specimen thickness (unit of measurement  $\text{kV/mm}$ ). Dielectric strength is particularly decisive with thin-walled components.

Note: In the case of black materials coloured with carbon black, a marked reduction of dielectric strength can occur.

---

## Dissipation factor

The dissipation factor represents the energy loss of a material due to dipolar movement of the molecules in dielectric applications with alternating voltage.

A high dissipation factor causes the generation of heat in the plastic part, which acts as a dielectric. The dissipation factor of plastic insulators in high-frequency applications such as radar devices, antenna applications and microwave parts should consequently be as low as possible.

The dissipation factor depends on

- Moisture content
- Temperature
- Frequency
- Voltage

---

## Comparative tracking index

To determine a material's insulating capacity, the comparative tracking index (CTI) is frequently used. This provides a statement on the insulation resistance of the surface (creep distance) of insulating materials. Even in the case of good insulating plastics, however, humidity and contamination on the surface (even temporarily) can result in failure of a component.

Frequently, leakage current is accompanied by small light arcs which can bridge well insulated areas if the soiling is unevenly spread. This can cause the insulating material to thermally decompose; a creep track forms. If this damage is allowed to continue, a creep path is created. This creep path can develop such a level of conductivity that it results in a short circuit.

The comparative tracking index can be heavily influenced by combination with material additives, in particular colour pigments.

**Electrical resistance [ $\Omega$ ]**

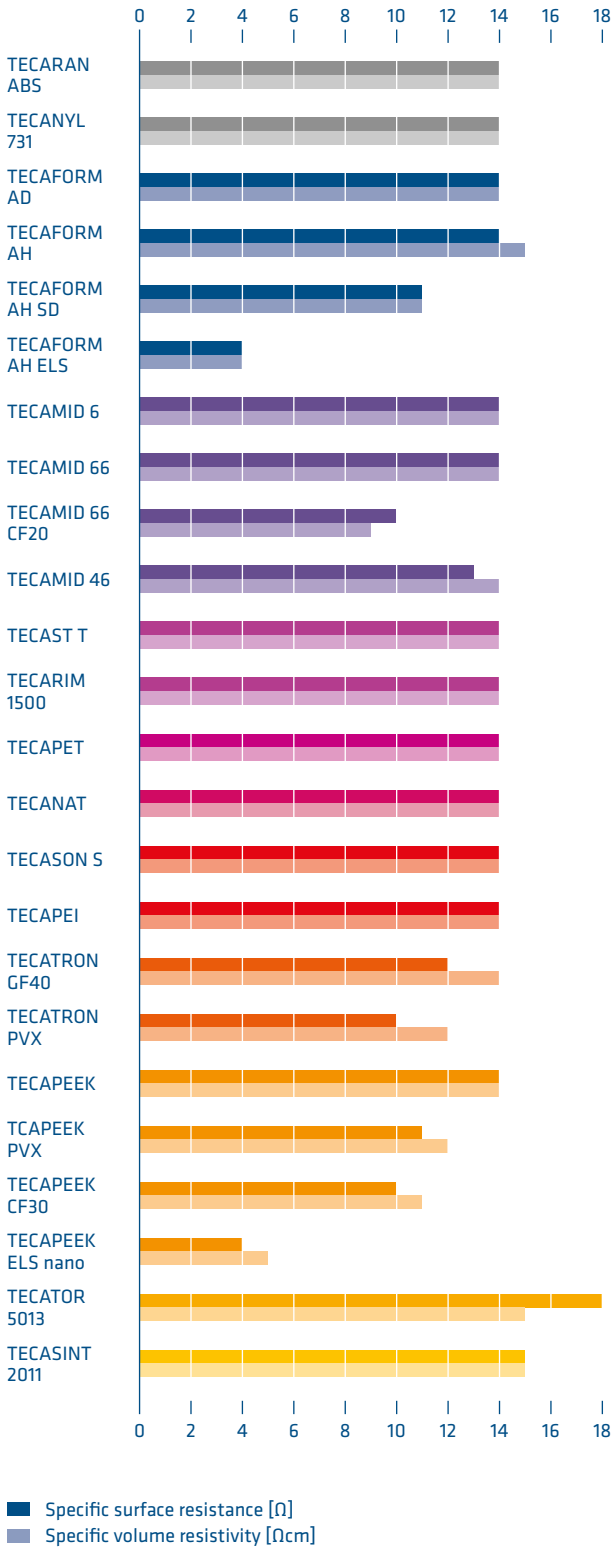

**Dielectric strength [kV/mm]**

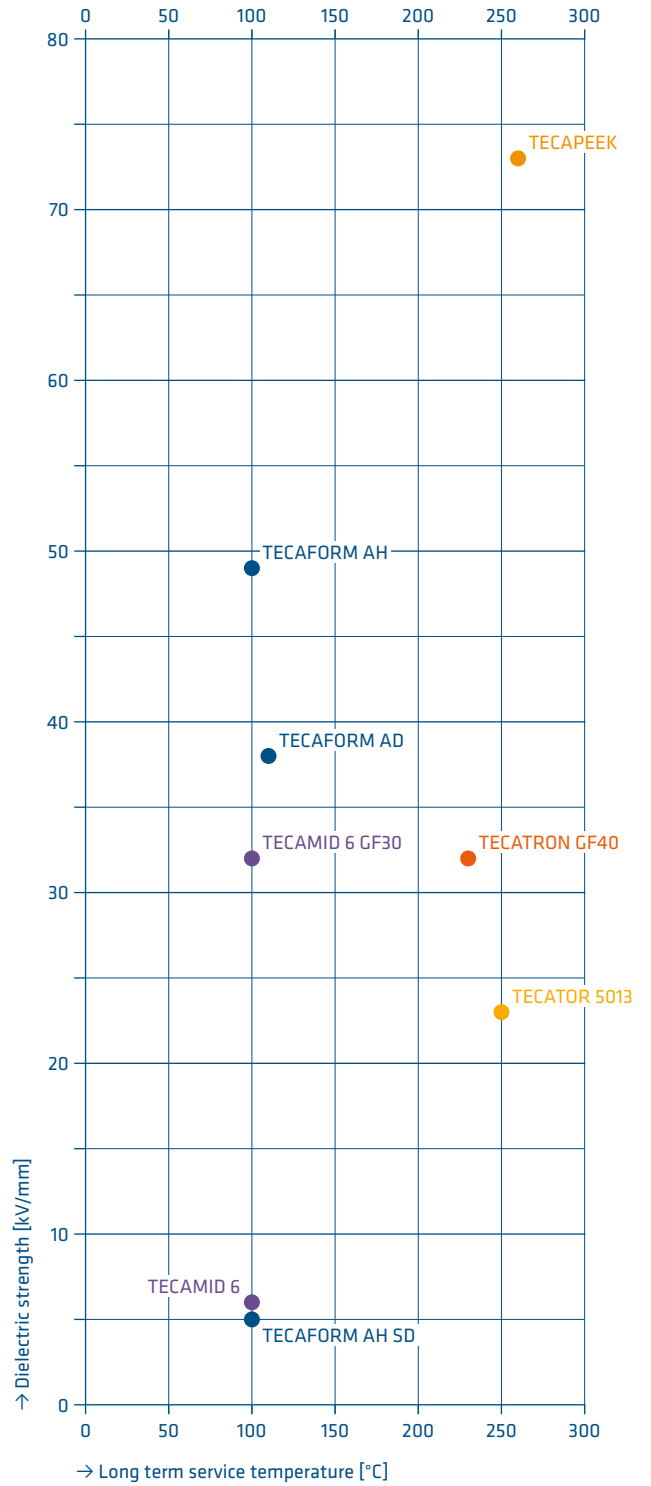

### Comparative tracking index [V]

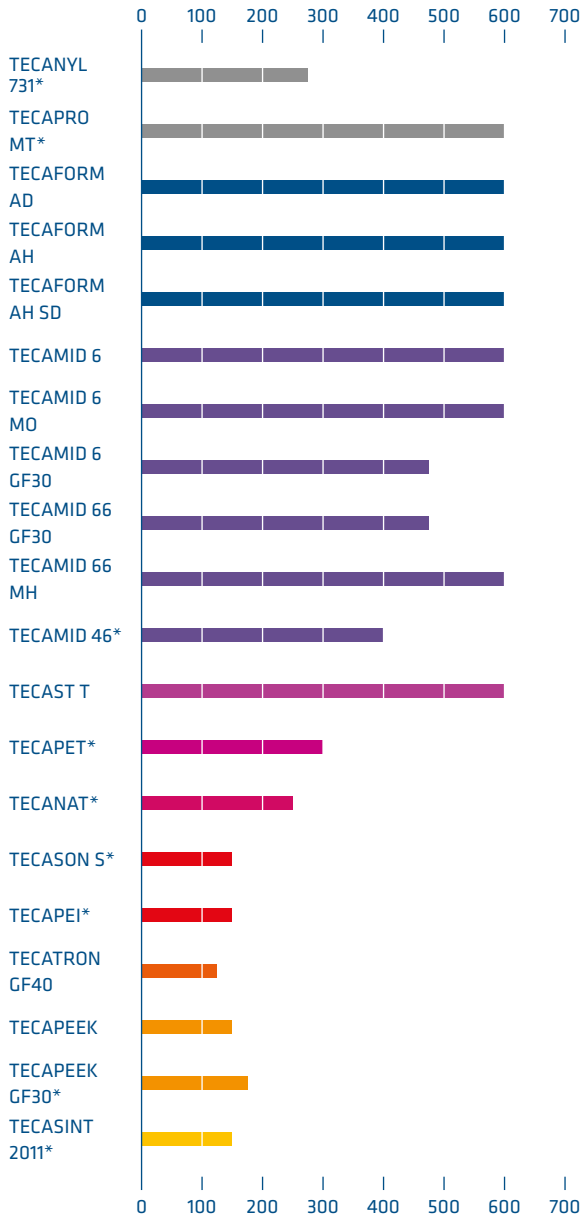

\* Published values

### Conductivity ranges Surface resistance [ $\Omega$ ]

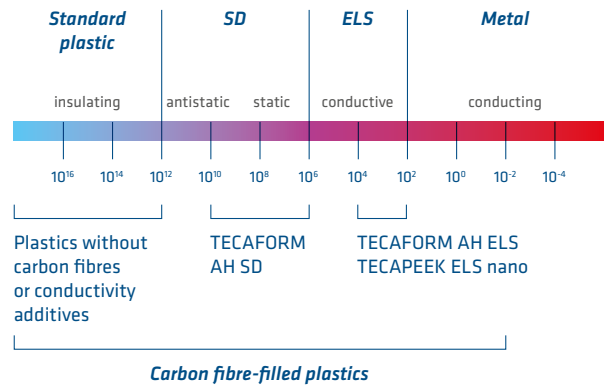

# Chemical resistance

Consequently, temperature, the concentration of agents, exposure periods and also mechanical load are all important criteria when testing for chemical resistance. The following table lists resistance to different chemicals. This information is provided to the best of our current knowledge and is designed to provide data about our products and their applications. Consequently it is not intended to

provide any legally binding assurance or guarantee of the chemical resistance of our products or their suitability for a specific application. Any existing industrial property rights must be taken into account. For a more specific application, we recommend producing your own verification. Standard tests are performed under normal climatic conditions 23/50 in accordance with DIN 50 014.

	TECASINT (PI)	TECAPEEK HT, ST (PEK, PEKEKK)	TECAPEEK (PEEK)	TECATRON (PPS)	TECAPEI (PEI)	TECASON E (PES)	TECASON P (PPSU)	TECASON S (PSU)	TECAFLON PTFE (PTFE)	TECAFLON PVDF (PVDF)	TECAMID 6 (PA 6)	TECAMID 46, 66 (PA 46, 66)	TECAMID 11, 12 (PA 11, 12)	TECARIM (PA 6 C + Elastomer)	TECANAT (PC)	TECAPET (PET), TECADUR PBT (PBT)	TECAFORM AH (POM-C)	TECAFORM AD (POM-H)	TECAFINE PP (PP)	TECAFINE PE (PE)	TECARAN ABS (ABS)	TECANYL (PPE)
Acetamide 50%			+						+	+	+	+	+	+			+	+	+	+	+	+
Acetone	+	+	+	+	-	-	-	-	+	0	+	+	0	+	-	0	+	+	+	+	-	-
Formic acid, aqueous solution 10%	+	+	+	+	+	+	+	+	+	+	-	-	-	-	-	0	-	-	+	+	+	+
Ammonia, aqueous solution 10%	-	+	+	+	-	0		0	+	+	0	0	0	0	-	-	+	0	+	+	+	+
Anone					-				+	0	+	+	+	+	-			+	+	0		
Benzine	+	+	+	+	+	+	+	+	+	+	+	+	+	+	-	+	+	+	0	0	0	-
Benzene	+	+	0	-	+	-	-	-	+	0	+	+	+	+	-	0	+	+	-	-	-	-
Bitumen	+	+							+	+	+	0			-		+	+	0	+		
Boric acid, aqueous solution 10%		+	0		+		0	+	+	-	-	-	-	-	+	-	-	-	+	+	+	+
Butyl acetate	+	+	+	-	-	-	-	-	+	-	+	+	+	+	-	-	+	+	0	0	-	-
Calcium chloride, aqueous solution 10%	+	+	+	+	+	+	+	+	+	+	+	+	+	+	+	+	+	0	+	+	+	+
Chlorobenzene	+	+	0	0	-	-	-	-	+	0	+	+	+	+	-	-	+	+	0	-	-	-
Chloroform	+	+	+	-	-	-	-	-	+	+	-	-	-	-	-	-	-	-	0	-	-	-
Cyclohexane	+	+	+	+	+	+	+	0	+	+	+	+	+	+	-	+	+	+	+	+	+	+
Cyclohexanone	+	+	+	-	-	-	-	-	+	0	+	+	+	+	-	+	+	+	+	+	-	+
Diesel oil	+	+	+	+	+	+	+	+	+	+	+	+	+	+	0	+	+	+	0	+	+	+
Dimethyl formamide	0	+	+	-	-	-	-	-	+	-	+	+	0	+	-	+	+	0	+	+	-	-
Diethyl phthalate		+	+	0	+	+	0	+	0	+	+	+	+	+	0	+	+	+	+	+	+	+
Dioxane	+	+	+	0	-	-	-	-	+	+	+	+	+	+	-	0	0	0	+	+	0	0
Acetic acid, concentrated	0	0	+	-	+	+	-	+	0	-	-	-	-	-	-	-	-	-	0	0	-	+
Acetic acid, aqueous solution 10%	+	+	+	+	+	+	+	+	+	-	-	0	-	+	0	+	0	+	+	+	+	+
Acetic acid, aqueous solution 5%	+	+	+	+	+	+	+	+	+	+	+	0	+	+	+	+	0	+	+	+	+	+
Ethanol 96%	+	+	+	+	+	+	+	+	+	0	0	0	0	0	+	+	+	+	+	+	+	+
Ethylacetate	+	+	+	0	-	0	-	-	+	0	+	+	+	+	-	0	+	+	+	+	+	+
Ethyl ether	+	+	+	+	+	+	+	+	+	+	+	+	+	+	-	+	+	+	+	+	+	+
Ethylene chloride	+		+						+	+	+	0	+	-	-	-	-	-	+	0	-	-
Hydrofluoric acid, 40%		-	0	-	-	-	-	-	0	+	-	-	-	-	-	-	-	-	+	+	0	+
Formaldehyde, aqueous solution 30%		+	+	+	+	+	+	+	+	0	0	0	0	0	+	+	+	+	+	+	+	+
Formamide		+							+	+	+	0	+	+	+	0	+	0	+	+	0	+
Freon, frigen, liquid	+	-	-	+	+	+	+	+	+	+	+	+	+	+	-	+	+	+	-	0	0	+
Fruit juices	+	+	+	+	+	+	+	+	+	+	+	+	+	+	0	+	+	0	+	+	+	+
Glycol	+	+	+	0	+	+	+	+	+	+	+	+	+	+	0	0	0	0	+	+	+	+
Glycantine, aqueous solution 40%	+	+	+	+	+	+	+	+	+	+	+	+	+	+	+	+	+	+	+	+	+	+
Glycerine	+	+	+	+	+	+	+	+	+	+	+	+	+	+	-	+	+	+	+	+	+	+
Urea, aqueous solution	+	+	+	+	+	+	+	+	+	+	+	+	+	+	+	+	+	+	+	+	+	+
Fuel oil	+	+	+	+	+	+	0	+	+	+	+	+	+	+	0	+	+	+	0	+	+	+
Heptane, hexane	+	+	+	+	+	+	+	+	+	+	+	+	+	+	+	+	+	+	+	-	+	+
Iso-octane	+	+	+	+	+	+	0	+	+	+	+	+	+	+	-	+	+	+	+	+	+	+
Isopropanol	+	+	+	+	+	+	0	+	+	+	+	0	+	-	0	+	+	+	+	0	+	+
Iodine solution, alcohol solution	+	0					+	0	+	+	-	-	-	-	-	-	0	+	+	0	+	+
Potassium lye, aqueous solution 50%	-	+	+	+	+	+	0	+	0	0	0	0	0	0	-	-	+	-	+	+	+	+
Potassium lye, aqueous solution 10%	0	+	+	0	+	+	+	+	0	+	+	+	+	+	-	-	+	-	+	+	+	+
Potassium dichromate, aqueous solution 10%	-								+	+	+	+	0		+	+	+	0	+	+	+	+

+ resistant o conditionally resistant - not resistant, also depending on concentration, time and temperature

	TECASINT (PI)	TECAPEEK HT, ST (PEK, PEKEK)	TECAPEEK (PEEK)	TECATRON (PPS)	TECAPEI (PEI)	TECASON E (PES)	TECASON P (PPSU)	TECASON S (PSU)	TECAFLON PTFE (PTFE)	TECAFLON PVDF (PVDF)	TECAMID 6 (PA 6)	TECAMID 46, 66 (PA 46, 66)	TECAMID 11, 12 (PA 11, 12)	TECARIM (PA 6 C + Elastomer)	TECANAT (PC)	TECAPET (PET), TECADUR PBT (PBT)	TECAFORM AH (POM-C)	TECAFORM AD (POM-H)	TECAFINE PP (PP)	TECAFINE PE (PE)	TECARAN ABS (ABS)	TECANYL (PPE)	
Potassium permanganate, aqueous solution 1%	+	+	+	+	+		+	+	+	+	-	-	-	-	+	+	+	+	+	+	+	0	+
Cupric (II) sulphate, 10%	+	+	+	+		+	+	+	+	+	+	+	+	+	+	+	+	-	+	+	+	+	+
Linseed oil	+	+	+		+	+	+	+	+	+	+	+	+	+	+	+	+	+	+	+	+	+	+
Methanol	+		+	0	+	0	0	+	0	+	+	0	+	+	-	+	+	+	+	+	0	+	
Methyl ethyl ketone	+	+	+	-	-	0	-	+	0	+	+	+	+	+	-	0	0	0	0	0	-	-	
Methylene chloride	+		0		-	-	-	+	+	0	0	-	0	-	-	0	0	-	0	-	+	+	
Milk	+	+	+	+	+	+	+	+	+	+	+	+	+	+	+	+	+	+	+	+	+	+	
Lactic acid, aqueous solution 90%	+	+	+	+	0			+	+	-	-	0	-	+	+	+	+	-	+	-	-	-	
Lactic acid, aqueous solution 10%	+	+	+	+	+	+	+	+	+	+	+	+	+	+	+	+	0	+	+	+	+	+	
Sodium carbonate, aqueous solution 10%	0	+	+	+	+	+	+	+	+	+	+	+	+	+	+	+	0	+	+	+	+	+	
Sodium chloride, aqueous solution 10%	+	+	+	+	+	+	+	+	+	+	+	+	+	+	+	+	+	+	+	+	+	+	
Sodium bisulphite, aqueous solution 10%	+	+	+	+		+	+	+	+	+	+	+	+	+	+	+	-	-	+	+	+	+	
Sodium nitrate, aqueous solution 10%	+		+					+	+	+	+	+	+	0	+	+	+	+	+	+	+	+	
Sodium thiosulphate, aqueous solution 10%	+	+	+			+	+	+	+	+	+	+	+	+	+	+	+	+	+	+	+	+	
Soda lye, aqueous solution 5%	0	+	+	0	+	+	+	+	0	+	+	+	+	-	0	+	-	+	+	+	+	+	
Soda lye, aqueous solution 50%	-	+	+	-	+	+	+	0	0	0	0	0	0	-	-	+	-	+	+	+	+	+	
Nitrobenzene	+		0	0	-			+	0	-	-	-	-	-	0	0	0	+	+	-	-	-	
Oxalic acid, aqueous solution 10%	+	+	+	+	+	+	+	+	+	0	0	0	0	+	+	-		+	+	+	+	+	
Ozone	0	+			+	+	+	+	+	-	-	-	-	+	0	-	-	0					
Paraffin oil	+		+	+	+	+		+	+	+	+	+	+	-	+	+	+	+	+	+	+	+	
Perchloroethylene	+	+	+	+	-	0	-	+	+	0	0	-	0	-	0	0	0	-	-	0			
Petroleum	+	+	+	+		+	+	+	+	+	+	+	+	+	+	+	+	+	+	+	0	+	
Phenol, aqueous solution	+		0	+	-	-	-	+	+	-	-	-	-	-	-	-	-	-	+	+	+	+	
Phosphoric acid, concentrated	0	+	+	+			+	+	+	-	-	-	-		+			+	+	+	+	+	
Phosphoric acid, aqueous solution 10%	0	+	+	+	+	+	+	+	+	-	-	-	-	+	+	0	-	+	+	+	+	+	
Propanol	+	+	+	+	+	+	+	+	+	+	+	-	+	+	+	+	+	+	+	+	+	+	
Pyridine	-	+	0	-	-			+	0	+	+	0	+	-		0	0	0	0	-	-	-	
Salicylic acid	+		-					+	+	+	+	+	+		0		-		+	+	+	+	
Nitric acid, aqueous solution 2%	+	+	+	+	+	+	+	+	+	-	-	-	-	0	+	-	-	+	+	+	+	-	
Hydrochloric acid, aqueous solution 2%	+	+	+	+	+	+	+	+	+	-	-	0	-	-	+	+	-	-	+	+	+	+	
Hydrochloric acid, aqueous solution 36%	-	+	0	+	+	0		+	-	-	-	-	-	0	-	-	-	+	+	+	+	+	
Hydrogen sulphide	+	+	+		0			+	+	+	+	+	+	-	+	+	+	0	0	-	-	-	
Sulphuric acid, concentrated 98%	-	-	-	+	-	-	-	+	0	-	-	-	-	-	-	-	-	+	0	-	-	-	
Sulphuric acid, aqueous solution 2%	+	+	+	+	+	+	+	+	+	-	-	-	-	+	+	+	-	+	+	+	+	+	
Hydrogen sulphide, aqueous solution		+	+	+	+	+	+	+	+	+	+	+	+	+	+	+	+	+	+	-	+	+	
Soap solution, aqueous solution	0	+	+	+	+	+	+	+	+	+	+	+	+	+	+	+	+	+	+	+	+	+	
Silicon oils	+	+	+	+	+	+	+	+	+	+	+	+	+	+	+	+	+	+	+	+	+	+	
Soda solution, aqueous solution 10%	0							+	+	+	+	+	+	+	+	+	+	+	+	+	+	+	
Edible fats, edible oils	+	+	+	+	+	+	0	+	+	+	+	+	+	+	+	+	+	+	+	+	+	+	
Styrene	+	+						+	0	+	+	+	+	-	0	+	+	0	0			-	
Tar	+	+		+	+	+		+	0	0	0	0	0	+	+	+	+	+	+	+	+	+	
Carbon tetrachloride	+	+	+	+	+	0	-	+	+	+	+	-	+	-	+	0	0	-	-	-	-	-	
Tetrahydrofurane	+	+	+	+	-	-		+	0	+	+	+	+	-	0	0	0	0	0	-	-	-	
Tetralin	+	+						+	+	+	+	+	+	-	+	0			0	-	-	-	
Toluene	+	+	+	0	-	-	0	-	+	+	+	+	+	-	0	+	0	+	0	-	-	-	
Transformer oil	+		+	+	+	+	+	+	+	+	+	+	+	+	+	+	+	+	0	+	+	+	
Triethanolamine	-		0	0				+	0	+	+	+	+	-	+	+	-	+	+	+	+	+	
Trichloroethylene	+	+	+	0	-	-	-	+	+	0	0	0	0	-	-	-	-	0	0	-	-	-	
Vaseline	+	+	+	+	+	+	+	+	+	+	+	+	+	+	+	+	+	+	0	+	+	+	
Wax, molten	+	+	+	+	+			+	+	+	+	+	+	+	+	+	+	0	0			+	
Water, cold	+	+	+	+	+	+	+	+	+	+	+	+	+	+	+	+	+	+	+	+	+	+	
Water, warm	-	+	+	+	+	+	+	+	+	0	0	0	0	0	-	0	-	0	0	0	+	+	
Hydrogen peroxide, aqueous solution 30%	-	0	0		+	+	+	+	0	-	-	-	-	+	+	-	-	+	+	+	+	+	
Hydrogen peroxide, aqueous solution 0.5%	+	+	+		+	+	+	+	+	-	-	-	-	+	+	+	0	+	+	+	+	+	
Wine, brandy	+	+			+	+	+	+	0	0	0	0	0	+	+	+	+	+	+	+	+	+	
Tartaric acid	+	+	+		+			+	+	+	+	+	+	+	+	0	0	+	+	+	+	+	
Xylene	+	+	+	+	-	0	0	-	+	+	+	+	0	+	-	0	+	+	-	-	-	-	
Zinc chloride, aqueous solution 10%	+	+	+	+	+	+	+	+	+	0	0	0	0	+	+	+	-	+	+	+	+	+	
Citric acid, aqueous solution 10%	+	+	+		+	+	0	+	+	0	0	0	0	+	+	0	-	+	+	+	+	+	

+ resistant o conditionally resistant - not resistant, also depending on concentration, time and temperature

# Moisture absorption

Moisture or water absorption is the ability of a material to absorb moisture from its environment (air, water). The degree of moisture absorption depends on the type of plastic and the ambient conditions such as temperature, humidity and contact time. This can influence primarily material properties such as dimensional stability, mechanical strength and electrical properties such as electrical conductivity and the dissipation factor.

Polyamides in particular tend to absorb higher amounts of moisture compared to other thermoplastics.

This property results in dimensional changes and lower strength values in finished parts. In addition, its electrical insulating behaviour also changes. For this reason, particularly in the case of components with narrow tolerances, the suitability of polyamide must be examined beforehand.

Alongside polyamides, most polyimides also demonstrate relatively high moisture absorption. With this material group, the main consequence of this characteristic is that the materials have very low hydrolysis resistance (humid environment at high temperatures).

Moisture absorption 96 h [%]

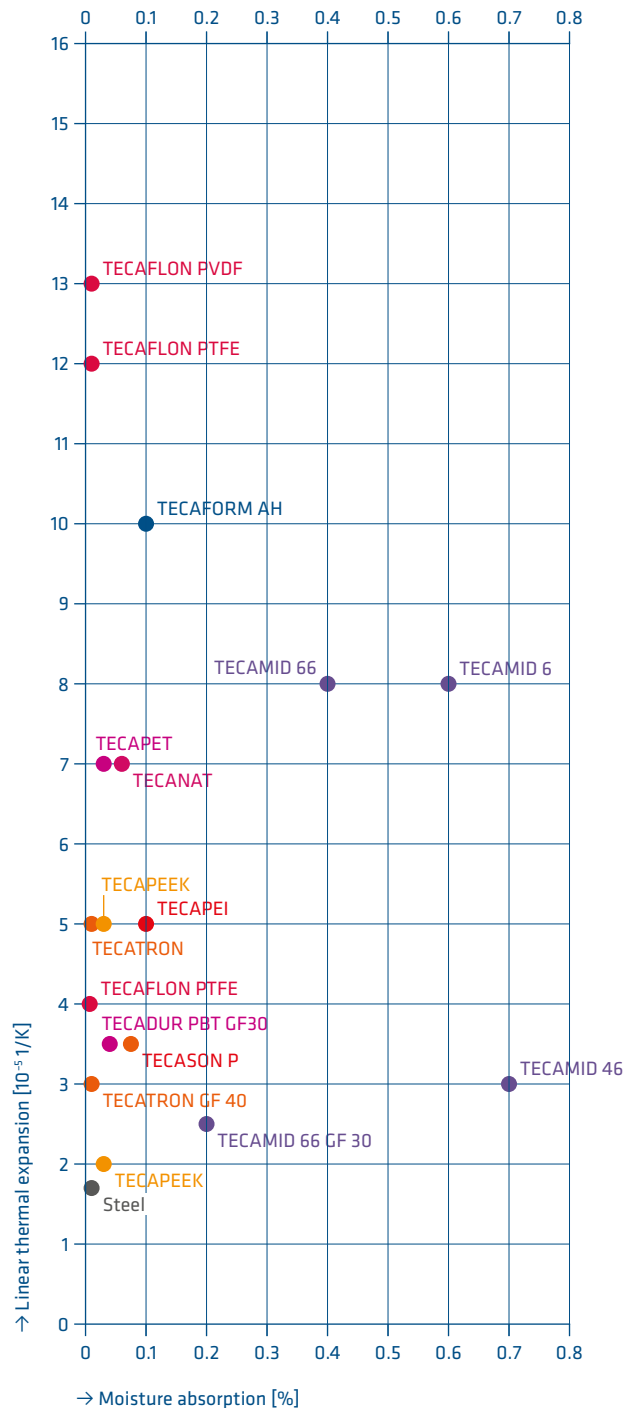



## Flame retardant classification

With regard to flame retardant classification, a variety of characteristics are of relevance. Combustibility is defined as the chemical property of materials to react with oxygen while emitting radiant energy. Only combustible materials are able to burn.

Flammability is another important property of a material. Most organic compounds are combustible on the direct application of energy. However, some plastics, in particular high-performance plastics, are flame retardant by their nature or inherently self-extinguishing, making them suitable for use where fire protection is an issue.

There are various standards available which classify the combustibility of polymers. Generally speaking, in most cases the internationally adopted combustibility tests set out by UL94 are performed.

Classification of combustibility behaviour according to UL94 takes place predominantly in accordance with the following criteria:

- UL94-HB (horizontal burning): Material burns and drips.
- UL94-V2 (vertical burning): Burning period < 30 seconds.  
After repeated flaming: Burning period < 250 seconds, flaming drips are admissible
- UL94-V1 (vertical burning): Burning period < 30 seconds.  
After repeated flaming: < 250 seconds, flaming drips are not admissible
- UL94-V0 (vertical burning): Burning period < 10 seconds.  
After repeated flaming: < 50 seconds, flaming drips are not admissible

Combustibility testing to UL94 is generally performed on raw material. Alongside testing in accordance with the specifications of UL or using a UL-accredited laboratory, listing (using so-called yellow cards) is also performed directly by UL itself. For this reason, a distinction must be made between materials with a UL listing and materials which only comply with the requirements of the respective UL classification (without listing).

Alongside flame retardant classification in accordance with UL94, a wide range of other industry-specific tests exists which classify the combustion behaviour of plastics. Depending on the specific branch of industry, not only combustion behaviour but under certain circumstances smoke development, drip behaviour and fume toxicity are also assessed.

---

### **Examples of typical additional flame retardant classification tests**

#### *Railway testing standards*

- DIN ISO 5510-2
- CEN TS 45545-2
- NFF 16101

#### *Aerospace*

- FAR25-853

#### *Automotive*

- FMVSS 302

# Radiation resistance

---

## **Radiation resistance**

Depending on their field of application, plastics can come into contact with different types of radiation, which under certain circumstances can permanently influence the structure of the plastics. The spectrum of electromagnetic waves ranges from radio waves with a large wavelength, through normal daylight with its short-wave UV radiation, to extremely short-wave X and gamma rays. The shorter the wavelength of the radiation, the greater the susceptibility of a plastic to damage.

---

## **Electromagnetic radiation**

An important characteristic in combination with electromagnetic waves is the dissipation factor. This describes the proportion of energy which can be absorbed by the plastic. Plastics with high dissipation factors heat up considerably in alternating electrical fields and are consequently not suitable for use as a material for high-frequency and microwave insulating applications. Polyamides, for example, can fracture or explode when used for a microwave application due to their high moisture absorption (due to extreme expansion of water molecules in the material).

---

## **Ultraviolet radiation**

UV radiation from sunlight is decisive in unprotected open-air applications. Plastics which are inherently resistant are to be found in the group of fluorinated polymers, for example PTFE and PVDF. Without suitable protective measures, various other plastics begin to yellow and become brittle depending upon the level of irradiation. UV protection is usually achieved using additives (UV stabilisers, black colouration using carbon black) or protective surface coatings (paints, metallization). The addition of carbon black is a low-cost and very effective way of stabilizing many plastics.

In this context, please refer to the light and weather resistance of plastics and our product handling and storage recommendations (→ p. 86).

---

## **Ionizing radiation**

Ionizing radiation such as gamma and X-rays are frequently to be found in medical diagnostics, radiation therapy, in the sterilization of disposable articles and also in the testing of materials and in test instrumentation, as well as in radioactive and other radiant environments.

The high energy radiation in these applications often leads to a decrease in the elongation characteristics and the development of brittleness.

The overall service life of the plastic is dependent upon the total amount of radiation absorbed. PEEK HT, PEEK, PI and the amorphous sulphur-containing polymers, for example, are proved to have very good resistance towards gamma radiation and X-rays. By contrast, PTFE and POM are very sensitive and therefore are practically unsuitable for this purpose.

The effect of high-energy radiation results in degradation or networking of the macromolecules in most plastics. If atmospheric oxygen is present when high-energy radiation is applied, as a rule oxidative degradation of the material occurs. During this process, the oxygen molecules diffuse into the plastic and occupy the free valences created by the radiation.

If no oxygen is present, the radiation will result rather in splitting of the molecule chains and subsequent crosslinking. Generally speaking, both variants occur simultaneously to differing extents. In every case, the influence of high-energy radiation results in a change to the mechanical characteristics (strength, rigidity, hardness or brittleness). This influence on the mechanical characteristics is reinforced under the influence of the radiation dose. Consequently no sudden return to the prior state takes place.

Information relating to the resistance of plastics (as shown in the following table) should only ever be considered a point of reference, as different parameters play a co-determining role (for instance part geometry, dosing rate, mechanical stress, temperature or ambient medium). For this reason, it is impossible to provide a generalized statement of the different damaging radiation doses for individual plastics.

## Weather resistance

Material	Response to atmospheric weathering
TECAFORM AH natural	-
TECAFORM AH black	(+)
TECAFORM AH ELS	(+)
TECAPET	-
TECAPET black	(+)
TECAMID 6	-
TECAM 6 MO	(+)
TECAMID 6 GF30 black	(+)
TECAST T	-
TECAST TM	(+)
TECAFLON PVDF	+
TECAFLON PTFE	+
TECASON S	-
TECAPEI	-
TECATRON GF40	-
TECATRON PVX	(+)
TECAPEEK	-
TECAPEEK black	-

## Radiation resistance [kGy]

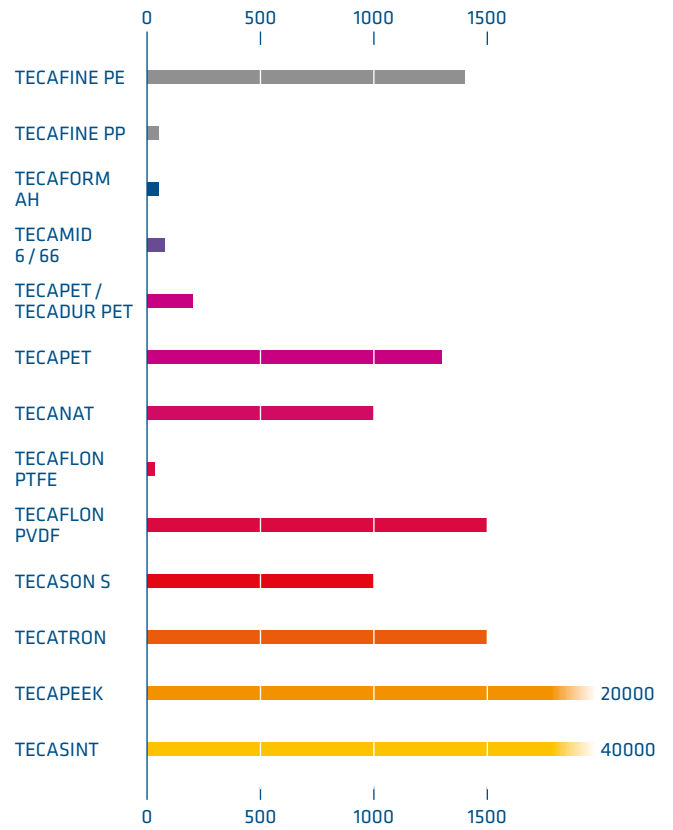

Radiation dose in Kilogray [kGy]  
which reduces elongation by less than 25%

# Certifications and approvals

To ensure that our products comply with the latest valid standards and regulations, a thorough working knowledge and continuous checking of the relevant rules and regulations is essential. It is the task of our Product Compliance Management Department to ensure that our products comply with these rules and to provide you with the relevant certifications.

Ensinger supplies materials which form the basis for a wide range of different products and processing applications. In some cases, these in turn require approval by the relevant regulatory bodies. The Ensinger product portfolio contains materials with a variety of different approvals, which include the following areas:

- Direct food contact  
(in compliance with FDA, BfR, 10/2011/EC, 1935/2004/EC 2002/72/EC, 3A SSI amongst others)
- Biocompatibility (in accordance with ISO 10993, USP Class VI amongst others)
- Drinking water contact (including KTW, WRAS, NSF61)
- Flammability (including UL94, BAM)
- Restriction of Hazardous Substances  
(RoHS amongst others)
- Other approvals

Working in close cooperation with our raw materials suppliers, authorities and institutes, we check the possible approvals and ensure, by using methods such as regular material tests, that the manufactured products comply, to as great an extent as possible, with the relevant regulatory requirements.

Depending on the material involved, we offer to issue the listed confirmations relating to the materials from our supply range if these are required by customers. In the interests of ensuring seamless traceability, these confirmations are only issued by Ensinger in direct connection with an actual order and with the material supplied. This minimizes the risk of nonconforming special-purpose products being inadvertently issued with certifications and gaining access to the market, as could occur if we permitted uncontrolled downloading of certificates from our website.

Special attention is currently being paid to approvals in the food and medical technology sector. Due to the strict regulations applicable to these areas of application, they deserve particular mention.

---

## Food approvals

Materials which come into direct contact with food must be produced in accordance with the principles of good manufacturing practice in such a way that they do not give off any of their constituent parts to the food under normal or foreseeable conditions which could pose a threat to human health.

This stipulation is defined in food regulatory standards and safeguarded by means of tests, controls and stipulations. Significant institutions in this field are the FDA (Food and Drug Administration) in the USA, the BfR (Federal Institute for Risk Assessment) in Germany and the EFSA (European Food Safety Authority) for the EU. Particular focus is on the EU regulations (1935/2004/EC, 10/2011/EC, ...).

Ensinger offers a broad portfolio of plastics from stock which comply with the requirements for direct food contact as stipulated by BfR, FDA and EU regulations.

For detailed information please refer to our brochure "Plastics used in food technology" at [www.ensinger-online.com](http://www.ensinger-online.com)



---

### **Medical technology approvals**

The biocompatibility of a material is a prerequisite for its use in medical applications with direct tissue contact, such as short-term implants, medical appliances or medicines. Biocompatibility is the attribute used for materials or assemblies which initiate no toxic or allergic reactions in the human body.

Ensinger materials suitable for medical applications (MT products) comply with requirements relating to direct contact with human tissue over a period of up to 24 hours. Special materials are also approved for longer contact periods. Ensinger offers biocompatible high-performance plastics for medical applications in a wide variety of colours.

By definition, plastic semi-finished products are not medical products or pharmaceutical products, but only an input material used in their production. As there is consequently no standardized stipulation of assessment of the biological suitability of semi-finished products, Ensinger has made its own selection from the wide spectrum of different biocompatibility tests contained in ISO 10993 and USP. This is intended to offer our customers the greatest possible support with the approval process for their medical or pharmaceutical end products. For this reason, Ensinger subjects stocked medical technology semi-finished products suitable for use as medical products with a contact period of <24 hours to a combined test at regular intervals: cytotoxicity / growth inhibition (ISO 10993-5), haemolysis (ISO 10993-4) and chemical analysis / fingerprinting (ISO 10993-18). These tests are biologically and toxicologically assessed (ISO 10993-1). Consequently Ensinger complies with the recommendations of ISO 10993-1 by following a step-by-step biological qualification process.

However, the biocompatibility demonstrated by Ensinger only provides confirmation of the semi-finished product. The finished component still has to be tested and approved by the distributor.

---

### **Works certificates**

Alongside various approval certificates, Ensinger also issues works certificates in compliance with DIN ISO 10204. The following variants are available:

#### *Works certificate in accordance with 2.1*

A certificate in which the manufacturer confirms that the supplied products comply with the requirements of the purchase order. No indication of test results.

#### *Works certificate in accordance with 2.2*

A certificate in which the manufacturer confirms that the supplied products comply with the requirements of the purchase order.

Additional indication of non-specific tests which are intended to determine whether products have been manufactured in accordance with the same product specification and using the same method or from input material or semi-finished products and comply with the requirements set out in the purchase order. The tested products do not necessarily have to originate from the delivery itself, but can originate from comparable products using the same material.

#### *Acceptance test in accordance with 3.1*

A certificate in which the manufacturer confirms that the supplied products comply with the requirements of the purchase order. With an indication of batch-related test results.

In the acceptance test certificate in accordance with 3.1, the manufacturer is permitted to adopt test results which were determined on the basis of batch-specific testing of the input material or semi-finished products used. The condition for this is the assurance of traceability.

For detailed information please refer to our brochure "Plastics used in food technology" at [www.ensinger-online.com](http://www.ensinger-online.com)





2008 10 28 10:28:00 AM







***It is only with the correct material that a design can achieve its required functionality, safety and service life. Primarily, the application conditions are what determine what is the right choice of material. Alongside the planned application, the search for a suitable plastic also takes into account all further reaching detailed requirements.***

In a qualified material recommendation, the existing information is compared with technical data and industry-specific empirical values. When the optimum material for the individual application has been determined, during the component design phase the suitability of the plastic is compared at an early stage with the aid of calculations before the material selection is then confirmed by practical testing.

*Material selection and calculations*

# Material chosen

## Criteria for material selection

When looking for a suitable plastic, the application conditions involved determine the material selection. For this reason, different specific framework conditions must be known and assessed, for example the planned purpose, the fields of application and further-reaching details relating to the characteristics and application conditions. With the aid of this information, qualified experts can compare the requirements to technical values and make an assessment. On the basis of defined criteria, in this way it is possible to continuously limit the choice of suitable materials.

However, the selection can only be a recommendation, which cannot replace practical testing.

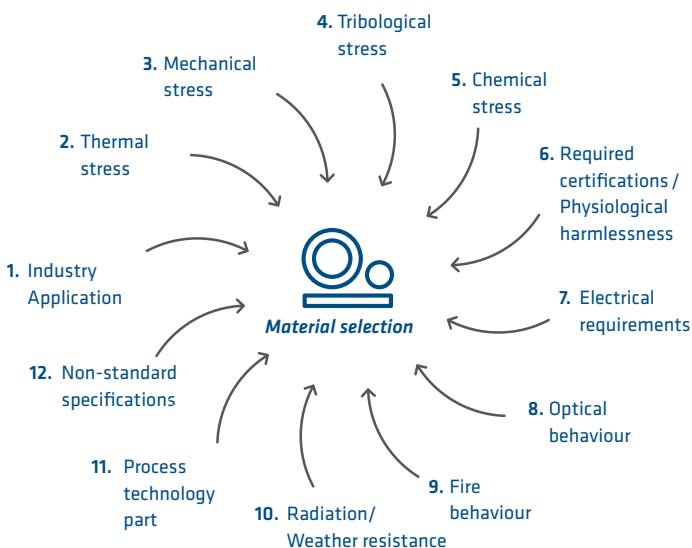

## Fundamental questions relating to the choice of material

Fundamental questions relating to the choice of material Generally speaking, thought must first be given to which type of material is preferred for the relevant application. This begs a number of different questions:

- Is plastic generally speaking an option for this application?
- Why plastic? Weight savings, improved characteristics in use?
- What was used previously?
- If a different material was used, what is the reason for changing?
- Why did the previous material not work?
- What problems occurred?

## Field of application / sector of industry

When the question of the application or sector of industry arises, this often significantly limits the material selection, as for different sectors generally speaking only special materials can be considered, for example due to the required approvals. Examples of this are the medical and food technology sectors. In the medical technology sector, generally only those materials are admissible which come with approval for direct bodily contact.

This means that the materials must be biocompatible. In the field of food technology, by contrast, approvals in compliance with FDA and also European standards (e.g. 10/2011/EC, 1935/2004/EC) are required.

Consequently, for these industries only materials which comply with requirements of the approvals can be considered.

## Thermal stress

Thermal stress is another key criterion restricting the selection of material. The temperatures transferred to the materials as a result of the application conditions must be taken into account here. Alongside the action of heat transferred from the outside, system-related heat created by factors such as friction must also be taken into consideration. Particularly characteristic temperatures are:

- Long-term service temperature
- Short-term maximum service temperature
- Negative service temperature
- Glass transition temperature
- Thermal dimensional stability
- Coefficient of linear thermal expansion

## Mechanical stress

To allow the suitability of a material to be assessed in terms of exposure to mechanical stress levels, the most detailed possible information about the envisaged stress must be available. In most cases, it is very helpful to obtain a sketch of the component with information relating to the mechanical stress. Particularly decisive factors here are:

- The type of stress (static, dynamic)
- Level of occurring forces
- Point and direction of force application
- Thermal stress during the application of force
- Time sequence
- Speed where applicable
- Admissible compression and elongation



---

### **Chemical stress**

If a component comes into contact with chemicals, its resistance to the substances in question must be considered in the light of the application conditions. Decisive factors here are:

- Contact temperature
- Contact time
- Concentration

It should be noted that the substances should be considered not only in the light of their application but also during processing (cooling lubricants etc.). In addition, in the case of substance mixtures, it should be borne in mind that these can behave completely differently in relation to a material than the individual substances alone.

---

### **Tribological stress**

If the case in consideration is a sliding-friction application, then on principle good sliding properties and abrasion characteristics are required. However, these variables usually depend directly on the other application conditions. In addition, the sliding system as such plays a key role.

- Application temperature
- Sliding speed
- Compression
- Sliding partner
- Surface properties

In principle it is only conditionally possible to assess the general suitability of a material in respect of its sliding friction abrasion behaviour, as the interaction of all occurring parameters can only be assessed in detail by conducting a practical test.

---

### **Required approvals / Physiological harmlessness**

The application conditions frequently provide a clue to the necessary approvals and certifications. As the relevant approvals are often dependent on the raw material used, a prior detailed clarification of the necessary certifications is required.

- Food (FDA, 10/2011, NSF 51 ...)
- Medicine (ISO 10993, USP class VI, ...)
- Drinking water (KTW, NSF 61, ...)
- Aerospace (ABS, ABD, ...)

---

### **Electrical requirements**

When electrical requirements exist, the key issue is generally whether an electrically dissipating / conducting or electrically insulating material is required. In order to avoid static charges, for example when producing electronic components, dissipating or conductive materials are required. This also applies in the case of ATEX applications (ATmosphere EXplosive). In contrast, in the case of components required to demonstrate high dielectric strength, good insulating materials are required.

---

### **Optical requirements**

Frequently optical requirements are imposed on a component. This can range from simple colouration, for example to reflect a corporate design, to transparent components for viewing windows through to colour coding (e.g. blue in food-related applications) for optical detection.

---

### **Requirements imposed on fire behaviour**

In many fields such as aerospace engineering, railways and so on, stringent demands are made on fire protection, in order to guarantee the safety of an application. Here, a material is frequently required to be self-extinguishing. Wide-ranging different sector-specific approvals exist with which the material / component is required to comply.

---

### **Requirements imposed on radiation / weather resistance**

If components are used for instance for outdoor applications, in radiology or in applications involving exposure to high-energy radiation such as power stations, the materials used require suitable radiation resistance. Decisive to the material selection are the exposure dosage and the relevant application conditions.

---

### **How is the component intended to be produced?**

The material selection is also dependent on the planned processing method. It should be known in advance, for instance, whether the component will be produced using a machining process, by injection moulding, direct forming or a similar process.

---

### **Non-standard specifications**

Alongside the requirements listed here, there may be a wide range of additional framework conditions, specifications or approvals to which a material must comply in a certain application. The relevant points must be separately tested and determined.

# Calculations

**In order to clarify the correlations described under the heading "Mechanical properties", the described influencing factors will first be explained in detail using a simple example:**

*Description:*

Let us assume that we have to produce a simple square machine underlay.

The underlay is placed flush with its surface on a level floor and is exposed over its whole surface to an even load of 1 ton.

- Given:
- h = 10 mm
  - w = 50 mm
  - l = 50 mm
  - m = 1,000 kg

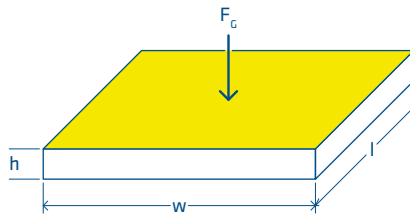

**1. The following applies:**

To be able to calculate the occurring surface compression, first of all the weight force is calculated as follows:

$$F_G = m \times g = 1,000 \text{ kg} \times 10 \text{ m/s}^2 = 10,000 \text{ N (simplified)}$$

This force must then be projected onto the contact surface. For the sake of simplicity, it is assumed that the force is ideally distributed over the contact surface. Initially, however, the contact surface in this case must be calculated as follows:

$$A = w \times l = 50 \text{ mm} \times 50 \text{ mm} = 2,500 \text{ mm}^2$$

in order to allow the surface compression to be subsequently calculated as follows:

$$p = F / A = 10,000 \text{ N} / 2,500 \text{ mm}^2 = 4.0 \text{ MPa}$$

In the application described above (simplified calculation) a surface compression of 4.0 MPa is determined.

In order to allow a suitable material to be recommended, however, the failure criterion still has to be determined. A distinction can be made here between several criteria:

- Breakage (application of load until material breakage)
- Stretching (application of load to the yield point)

- Crack formation (application of load until irreversible damage in the micro-range, crazing)
- Application-specific max. admissible deformation

For the application described here, a maximum admissible deformation of 1% is assumed.

With this value, the admissible surface compression may be determined with the aid of a quasi-statistical stress-strain curve. Even if the stress involved in the described case is compression stress, it is possible to revert here to results from the tensile test, as with only a few exceptions the tensile strength of a material is smaller than the compressive strength. Consequently, at the same time a certain safety allowance is also taken into consideration. As the results of the tensile test are easily accessible, this also means that a good data base is available.

**Fig. 1**  
Stress-strain curve  
PA 66 (dry)

— **TECAMID 66**

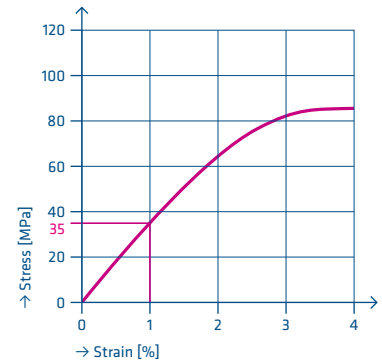

With a load of 4 MPa and admissible deformation of 1%, for example, the material TECAMID 66 may be used. Under these conditions, surface compression can be applied up to appr. 35 MPa

**2. Influence of moisture**

The data used above was determined on test specimens which had just been freshly injected. However, their application takes place under normal climatic conditions. For this reason, particularly in the case of polyamides, which generally have relatively high moisture absorption, the actual strength under normal climatic conditions must be taken as a basis for assessment of the application:

**Fig. 2**  
Stress-strain  
curve PA 66  
(conditioned)

— **TECAMID 66**

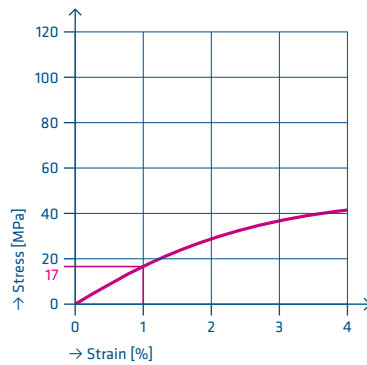

As a result of the moisture absorption, the mechanical strength drops tangibly. Surface compression of 4 MPa at 1% admissible deformation is still possible, but under these conditions a load of appr. 17 MPa can no longer be supported.

### 3. Influence of time

The machine is required to remain standing over a long period on the underlay. The maximum underlay deformation of 1% should not be exceeded. Here, we assume a value for time of 10,000 h. This corresponds roughly to one year. For this type of estimate, isochronous stress-strain curves can be used. These show the stress-strain progression for different stress periods in a single diagram.

**Fig. 3**  
Isochronous stress-strain  
curve PA 66  
(23 °C, conditioned)

— **TECAMID 66**

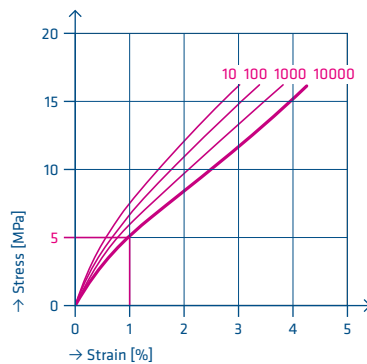

The diagram above indicates an admissible surface area compression of appr. 5 MPa for a load duration of 10,000 h and an admissible deformation of 1%. The underlay would still fulfil its purpose under these conditions. However, the influencing factors of humidity and time already substantially reduce the admissible surface area compression.

### 4. Influence of temperature

Let us assume that the machine being supported heats up to a temperature of appr. 60 °C in use. As the strength and rigidity of a material reduce at elevated temperatures while toughness increases, this circumstance must also be taken into account in the configuration of the underlays.

For this, isochronous stress-strain diagrams can be used which were determined at a corresponding temperature.

**Fig. 4**  
Isochronous  
stress-strain  
curve PA 66 (60 °C)

— **TECAMID 66**

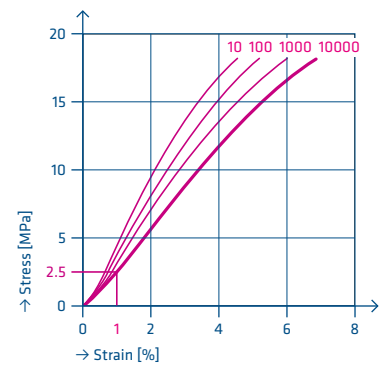

With a load duration of 10,000 h and an admissible deformation of 1% at an elevated temperature of 60 °C, an admissible surface area compression of appr. 2.5 MPa is determined. This is lower than the actual effective surface area compression. In this case, suitable measures must be taken to counteract this effect. The actual surface area compression can be reduced, for instance, by making design adjustments such as increasing the support surface area. Another possibility is to improve the material characteristics, for example by means of glass fibre reinforcement, or by changing to a different material.

This calculation has been simplified in a number of ways, and is intended only to demonstrate the extent to which the plastic characteristics depend on the ambient conditions. The more data is available, the more effectively it is possible to make a correct material choice.

In many cases, extensive material data is not available. However, estimated calculations can be made by interpolating or extrapolating the existing data.





*Machining is the predominant method used for further processing plastic semi-finished products. In order to produce high-quality, durable, precisely dimensioned and flawless components, as much attention must be paid to the tools and processing parameters as to the characteristics of the specific materials.*

In most cases, thermoplastics can be very successfully joined by means of welding and bonding (or to other materials). A general rule for all further processing steps is to ensure that the components are thoroughly cleaned.

The following pages contain an overview of different further processing methods and an indication of which material-specific differences have to be taken into account.



*Further processing*

# Processing plastics

## General remarks\*

Unreinforced thermoplastics can be machined using high-speed steel tools. Machining reinforced materials calls for the use of carbide tools. In either case, only flawlessly sharpened tools should be used. Due to the poor thermal conductivity of plastics, steps must be taken to ensure good heat dissipation. The best form of cooling is heat dissipation through the produced chips.

## Dimensional stability

Dimensionally precise parts can only be made from stress-annealed semi-finished products. Otherwise, the heat generated by machining will inevitably lead to release of processing tension and component warping. If high stock removal volumes occur, intermediate annealing may be advisable after the main machining process in order to dissipate any build-up of thermal tension. We can provide information on the necessary temperatures and timings on a material-specific basis. Materials with excessive moisture absorption (e.g. polyamides) must be conditioned before machining where applicable. Plastics require greater production tolerances than metals. In addition, it is important to bear in mind that thermal expansion is many times greater than with metal.

## Machining methods

**1. Turning** Guideline values for tool geometry are given in the table (→ S. 77). For surfaces of particularly high quality, the cutting edge must be configured as a broad-nosed finishing cutting edge as illustrated in Fig. 1. For parting-off operations, the lathe tool should be ground as illustrated in Fig. 2, in order to prevent the formation of burrs. When working with thin-walled and particularly flexible workpieces, however, it is more advantageous to work with tools which have a knife-like cutting geometry (Fig. 3).

Fig. 1 Broad-nosed finishing cutting edge

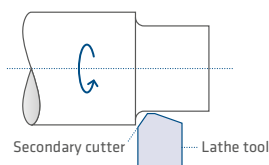

Fig. 2 Grinding prevents burr formation

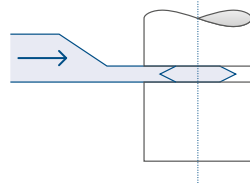
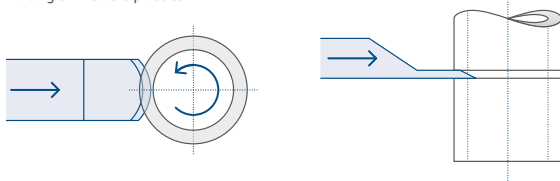

Fig. 3 Parting off flexible plastics



\* We provide written and oral application advice designed to support you in your work. This is offered in the form of a non-binding recommendation, also in respect of any third-party industrial property rights. We are unable to accept any liability for damage occurring during machining.

**2. Milling** For plane surfaces, end milling is more economical than peripheral milling. During circumferential and profile milling, tools should not have more than two cutting edges in order to minimize vibrations caused by a high number of cutting edges, and chip spaces should be adequately dimensioned. Optimum cutting performance and surface finish quality are achieved with single-cutter tools.

**3. Drilling** Generally speaking, twist drills can be used; These should have a twist angle of 12° to 16° and very smooth spiral grooves for optimum chip removal. Larger diameters should be pre-drilled or should be produced using hollow drills or by cutting out. When drilling into solid material, particular attention should be paid to properly sharpened drills, as otherwise the resulting compressive stress can increase to the point that the material can split

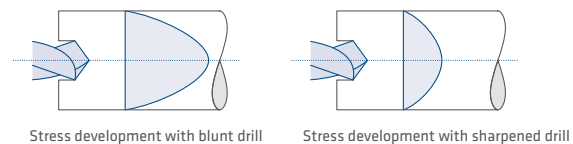

Reinforced plastics have higher residual processing stresses with lower impact strength than unreinforced plastics, and are consequently particularly susceptible to cracking. Where possible they should be heated prior to drilling to a temperature of around 120 °C (heating time appr. 1 hour per 10 mm cross-section). This method is also advisable when machining polyamide 66 and polyester.

**4. Sawing** It is important to avoid unnecessary heat generation due to friction as, when sawing mostly thick-walled parts, relatively thin tools are used. Well sharpened saw blades with large tooth offsets are therefore recommended for sawing.

**5. Thread cutting** The best way to cut threads is using thread chasers; the formation of burr can be avoided by using twin-toothed chasers. Die nuts are not advisable, as these can cause additional cutting when withdrawing the nut. When using tap drills, a machining allowance (dependent on the material and diameter, guideline value: 0.1 mm) is frequently required.

**6. Safety precautions** Failure to observe the machining guidelines can result in localized overheating which can lead to material degradation. The decomposition products released from materials such as PTFE fillers must be captured by an extraction device. In this context, tobacco products must be kept out of the production area due to the risk of toxic effects.



# Machining Guidelines

	Sawing				Drilling				
	clearance angle	rake angle	cutting speed	pitch	number of teeth	twist angle	rake angle	cutting speed	feed rate
TECAFINE PE, PP	20-30	2-5	500	3-8	Z2	25	90	50-150	0.1-0.3
TECAFINE PMP	20-30	2-5	500	3-8	Z2	25	90	50-150	0.1-0.3
TECARAN ABS	15-30	0-5	300	2-8	Z2	25	90	50-200	0.2-0.3
TECANYL	15-30	5-8	300	3-8	Z2	25	90	50-100	0.2-0.3
TECAFORM AD, AH	20-30	0-5	500-800	2-5	Z2	25	90	50-150	0.1-0.3
TECAMID, TECARIM, TECAST	20-30	2-5	500	3-8	Z2	25	90	50-150	0.1-0.3
TECADUR/TECAPET	15-30	5-8	300	3-8	Z2	25	90	50-100	0.2-0.3
TECANAT	15-30	5-8	300	3-8	Z2	25	90	50-100	0.2-0.3
TECAFLON PTFE, PVDF	20-30	5-8	300	2-5	Z2	25	90	150-200	0.1-0.3
TECAPEI	15-30	0-4	500	2-5	Z2	25	90	20-80	0.1-0.3
TECASON S, P, E	15-30	0-4	500	2-5	Z2	25	90	20-80	0.1-0.3
TECATRON	15-30	0-5	500-800	3-5	Z2	25	90	50-200	0.1-0.3
TECAPEEK	15-30	0-5	500-800	3-5	Z2	25	90	50-200	0.1-0.3
TECATOR	15-30	0-3	800-900	10-14	Z2	25	90	80-100	0.02-0.1
TECASINT	5-10	0-3	800-900	3-4	Z2	25	120	80-100	0.02-0.1
Reinforced/filled TECA products*	15-30	10-15	200-300	3-5	Z2	25	100	80-100	0.1-0.3

\* Reinforcing agents/fillers:  
Glass fibres, glass beads, carbon fibres, graphite, mica, talcum, etc.

**Heat before sawing:**  
from Ø 60 mm TECAPEEK GF/PVX, TECATRON GF/PVX  
from Ø 80 mm TECAMID 66 GF, TECAPET, TECADUR PBT GF  
from Ø 100 mm TECAMID 6 GF, 66, 66 MH

**Heat before drilling in the centre:**  
from Ø 60 mm TECAPEEK GF/PVX, TECATRON GF/PVX  
from Ø 80 mm TECAMID 66 MH, 66 GF, TECAPET, TECADUR PBT GF  
from Ø 100 mm TECAMID 6 GF, 66, TECAM 6 MO, TECANYL GF

	Milling			Turning				
	number of teeth	cutting speed	feed rate	clearance angle	rake angle	side angle	cutting speed	feed rate
TECAFINE PE, PP	Z1-Z2	250-500	0.1-0.45	6-10	0-5	45-60	250-500	0.1-0.5
TECAFINE PMP	Z1-Z2	250-500	0.1-0.45	6-10	0-5	45-60	250-500	0.1-0.5
TECARAN ABS	Z1-Z2	300-500	0.1-0.45	5-15	25-30	15	200-500	0.2-0.5
TECANYL	Z1-Z2	300	0.15-0.5	5-10	6-8	45-60	300	0.1-0.5
TECAFORM AD, AH	Z1-Z2	300	0.15-0.5	6-8	0-5	45-60	300-600	0.1-0.4
TECAMID, TECARIM, TECAST	Z1-Z2	250-500	0.1-0.45	6-10	0-5	45-60	250-500	0.1-0.5
TECADUR/TECAPET	Z1-Z2	300	0.15-0.5	5-10	0-5	45-60	300-400	0.2-0.4
TECANAT	Z1-Z2	300	0.15-0.4	5-10	6-8	45-60	300	0.1-0.5
TECAFLON PTFE, PVDF	Z1-Z2	150-500	0.1-0.45	5-10	5-8	10	150-500	0.1-0.3
TECAPEI	Z1-Z2	250-500	0.1-0.45	10	0	45-60	350-400	0.1-0.3
TECASON S, P, E	Z1-Z2	250-500	0.1-0.45	6	0	45-60	350-400	0.1-0.3
TECATRON	Z1-Z2	250-500	0.1-0.45	6	0-5	45-60	250-500	0.1-0.5
TECAPEEK	Z1-Z2	250-500	0.1-0.45	6-8	0-5	45-60	250-500	0.1-0.5
TECATOR	Z1-Z2	60-100	0.05-0.35	6-8	0-5	7-10	100-120	0.05-0.08
TECASINT	Z1-Z2	90-100	0.05-0.35	2-5	0-5	7-10	100-120	0.05-0.08
Reinforced/filled TECA products*	Z1-Z2	80-450	0.05-0.4	6-8	2-8	45-60	150-200	0.1-0.5

\* Reinforcing agents/fillers:  
Glass fibres, glass beads, carbon fibres, graphite, mica, talcum, etc.

- Preheat material to 120 °C
- Caution when using coolants: susceptible to stress cracking

For detailed information, please also refer to our brochure "Guidelines for Machining Enginger Semi-Finished Engineering Plastics" at [www.ensinger-online.com](http://www.ensinger-online.com)



# Annealing

## Annealing

The annealing process is a heat treatment for semi-finished products, mouldings and finished parts. The products are heated slowly and evenly to a material-specific defined temperature level. This is followed by a holding time which depends on the material thickness in order to fully heat through the shaped component. Subsequently the material has to be slowly and evenly cooled back down to room temperature.

### Typical annealing cycle

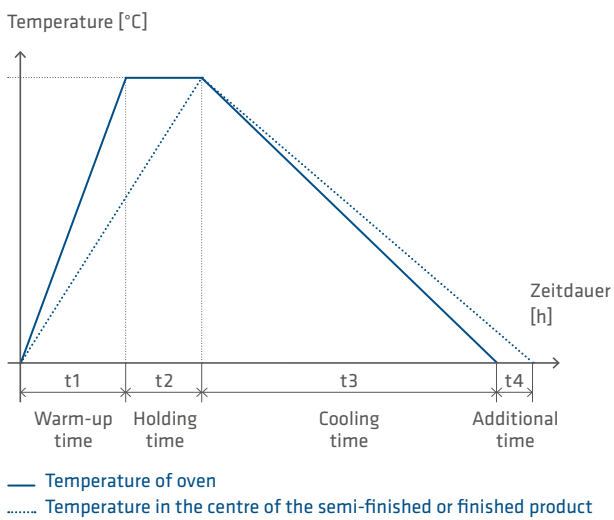

## Annealing to reduce stress

Ensinger semi-finished products are always subjected in principle to a special annealing process after production to reduce the internal tension created during manufacture. Annealing is carried out in a special recirculating air oven, but can also take place in an oven with circulating nitrogen or in an oil bath.

Annealing results in increased crystallinity, as well as improved strength and chemical resistance. It also brings about a reduction of inner stress as described above and increases dimensional stability over a wide temperature range. This ensures that the material you receive remains dimensionally stable during and after the machining process and can be more easily machined.

Benefits of annealing:

- Residual stress created during the manufacturing or processing phase can be largely reduced by annealing.
- Optimized material crystallinity and mechanical material characteristic values.
- Formation of an even crystalline structure in the materials.
- In some cases improved chemical resistance.
- Reduced tendency for warping and dimensional changes (during or after processing)
- Sustainable improvement of dimensional stability

Material	Polymer designation	Warm-up	Holding*	Cooling
<b>TECASINT</b>	PI	2 hrs to 160 °C	6 hrs to 280 °C	2 hrs to 160 °C / 10 hrs at 280 °C at 20 °C per hour to 40 °C
<b>TECAPEEK</b>	PEEK	3 hrs to 120 °C	4 hrs to 220 °C	1.5 hrs per cm of wall thickness at 20 °C per hour to 40 °C
<b>TECATRON</b>	PPS	3 hrs to 120 °C	4 hrs to 220 °C	1.5 hrs per cm of wall thickness at 20 °C per hour to 40 °C
<b>TECASON E</b>	PES	3 hrs to 100 °C	4 hrs to 200 °C	1 hrs per cm of wall thickness at 20 °C per hour to 40 °C
<b>TECASON P</b>	PPSU	3 hrs to 100 °C	4 hrs to 200 °C	1 hrs per cm of wall thickness at 20 °C per hour to 40 °C
<b>TECASON S</b>	PSU	3 hrs to 100 °C	3 hrs to 165 °C	1 hrs per cm of wall thickness at 20 °C per hour to 40 °C
<b>TECAFLON PVDF</b>	PVDF	3 hrs to 90 °C	3 hrs to 150 °C	1 hrs per cm of wall thickness at 20 °C per hour to 40 °C
<b>TECANAT</b>	PC	3 hrs to 80 °C	3 hrs to 130 °C	1 hrs per cm of wall thickness at 20 °C per hour to 40 °C
<b>TECAPET</b>	PET	3 hrs to 100 °C	4 hrs to 180 °C	1 hrs per cm of wall thickness at 20 °C per hour to 40 °C
<b>TECADUR PBT GF30</b>	PBT	3 hrs to 100 °C	4 hrs to 180 °C	1 hrs per cm of wall thickness at 20 °C per hour to 40 °C
<b>TECAMID 6</b>	PA 6	3 hrs to 90 °C	3 hrs to 160 °C	1 hrs per cm of wall thickness at 20 °C per hour to 40 °C
<b>TECAMID 66</b>	PA 66	3 hrs to 100 °C	4 hrs to 180 °C	1 hrs per cm of wall thickness at 20 °C per hour to 40 °C
<b>TECAFORM AH</b>	POM-C	3 hrs to 90 °C	3 hrs to 155 °C	1 hrs per cm of wall thickness at 20 °C per hour to 40 °C
<b>TECAFORM AD</b>	POM-H	3 hrs to 90 °C	3 hrs to 160 °C	1 hrs per cm of wall thickness at 20 °C per hour to 40 °C

\* At maximum temperature, unless otherwise specified.



---

### **Intermediate annealing**

An intermediate annealing stage can be expedient when machining critical components. This applies in particular:

- Where narrow tolerances are required
- If the parts being produced have a tendency to warp due to their shape (asymmetry, restricted cross-sections, pockets or grooves).
- When machining fibre-reinforced / filled materials (fibre orientation can increase the tendency to warp)
  - ↳ The machining process can result in additional higher levels of stress being created in the component
- When using blunt or unsuitable tools:
  - ↳ Inner stress is created
- In case of excessive transfer of heat into the component – created by using unsuitable speeds and feed rates
- With high stock removal volumes – particularly where machining takes place on one side

An intermediate annealing step can help to reduce these tensions and alleviate the risk of warping. Here, to ensure adherence to required dimensions and tolerances, the following should be noted:

- Before the intermediate annealing phase, first rough machine the component, leaving a machining allowance (roughing), as annealing can result in a certain degree of component shrinkage.
- Final dimensioning of the part should only take place after annealing.
- Provide adequate support for the component during the intermediate annealing phase:
  - ↳ Avoids warping occurring during annealing

For detailed information,  
please also refer to our brochure  
"Guidelines for Machining Ensinger  
Semi-Finished Engineering Plastics"  
at [www.ensinger-online.com](http://www.ensinger-online.com)



# Welding

Plastic welding to join two thermoplastic materials is a common and highly developed joining technique. A variety of different processes are available which work either on a no-contact basis (heating element, ultrasound, laser, infrared, gas convection welding) or by contact (friction, vibration welding). Depending on the process used, certain design guidelines must be observed during the design phase in order to guarantee optimum connection. In the case of high-temperature plastics, it should be noted that an extremely high input of energy is required for plastification of materials. The welding method to be used depends on these factors (shaped part geometry and size, material). Common welding techniques used for processing plastics are:

- Heating element welding
- Infrared welding
- Gas convection welding
- Friction welding
- Laser welding
- Ultrasound welding
- Thermal contact welding
- High-frequency welding

## Contacts for welding plastics:

### bielomatik Leuze GmbH + Co. KG

Daimlerstrasse 6 - 10  
72639 Neuffen  
Tel. +49 (0)7025 12 0  
Fax +49 (0)7025 12 200  
www.bielomatik.de

### Kuypers Kunststofftechnik BV

Koningshoek 8  
5094 CD Lage Mierde  
Niederlande  
Tel. +31 (0)13 509 66 11  
Fax +31 (0)13 509 25 87  
www.kuypers.com

### Widos

Wilhelm Dommer Söhne GmbH  
Einsteinstr. 5  
71254 Ditzingen-Heimerdingen  
Tel. +49 (0)7152 9939 0  
Fax +49 (0)7152 9939 40  
www.widos.de

## Materials and suitable welding processes

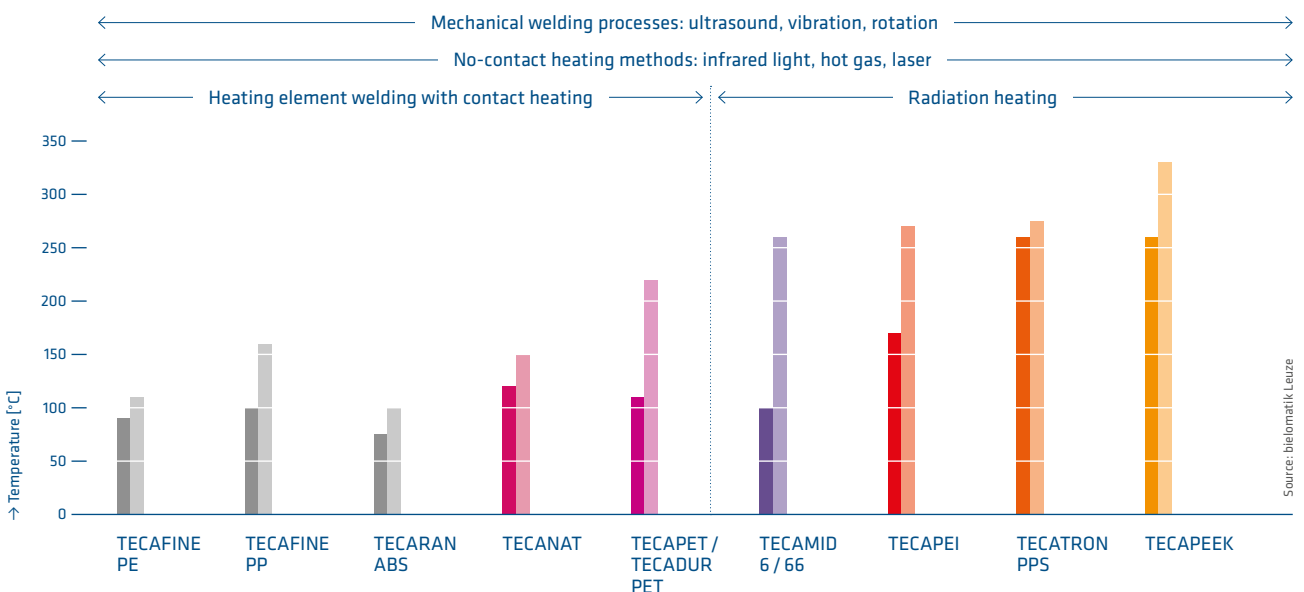

## Welding processes

Method	Heating element and hot gas welding	Ultrasound welding	Vibration / friction welding	Laser welding
	<p>1. Heating element, Carriage with tool</p> <p>2. Joining / cooling</p>	<p>Sonotrode, Workpieces</p>		
<b>Principle</b>	Heating the joining partners using a heating element or hot gas, joining under pressure	Heating a joining zone (with a specific geometry) by ultrasound vibration	Heating the joining partners by vibration or friction, joining under pressure	Heating the joining partners using a laser beam
<b>Welding time</b>	20 to 40 s	0.1 to 2 s	0.2 to 10 s	
<b>Benefits</b>	High strength, low cost	Minimal cycle times, easy process automation	Suitable for large parts, oxidation-sensitive plastics can be welded	High strength, almost any optional seam geometry, high precision

Thermal conduction	Radiation	Convection	Friction			
<b>Heating element welding</b>	<b>Heating element welding</b>	<b>Laser beam welding</b>	<b>Hot gas welding</b>	<b>Extrusion welding</b>	<b>Inner friction</b>	<b>Outer friction</b>
Induction welding with insert heating element in metal	IR light welding		Hot gas riveting		High-frequency welding	Rotation welding
Welding with insert heating element in metal					Ultrasound welding	Vibration welding

Source: bielomatik, Leuze

# Bonding

Bonding technology is a very efficient joining method which permits plastics to be permanently joined to themselves or other materials. The chemical joining (bonding) of components offers a range of benefits compared to other joining methods:

- Even distribution of stress
- No damage to materials
- No warping of joined parts
- Different material combinations can be joined
- The separating joint is sealed at the same time
- A smaller number of components is required

Decisive factors for a good bonded joint:

- Material characteristics
- Adhesive
- Adhesive layer
- Surface (preliminary treatment)
- Geometric design of the bonded joint
- Application and load conditions

To increase the strength of a bonded joint, it is advisable to pre-treat the surfaces when bonding plastics in order to enhance surface activity.

- Cleaning and degreasing the material surface
- Increasing the size of the mechanical surface by grinding or sand blasting (particularly recommended)
- Physical activation of the surface by flame, plasma or corona treatment
- Chemical etching for the formation of a defined boundary layer
- Primer application

When bonding plastics, tension peaks should be avoided and a compressive, tensile or shear load should preferably be applied to the adhesive bond joint. Avoid flexural, peeling or plain tensile stresses. Where applicable, the design should be adjusted so that the bonded joint can be configured for suitable levels of stress.

**When bonding plastics, tensional load should be avoided and a compressive, tensile or shear load should preferably be applied to the adhesive bond joint.**

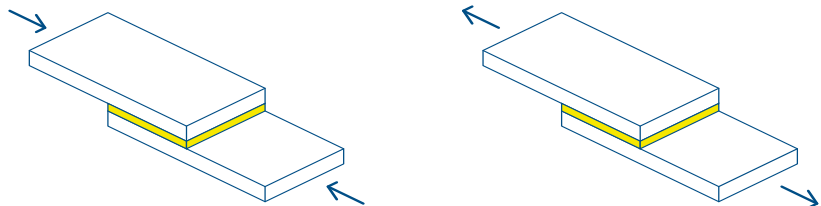

**Avoid flexural, peeling or plain tensile stresses.**

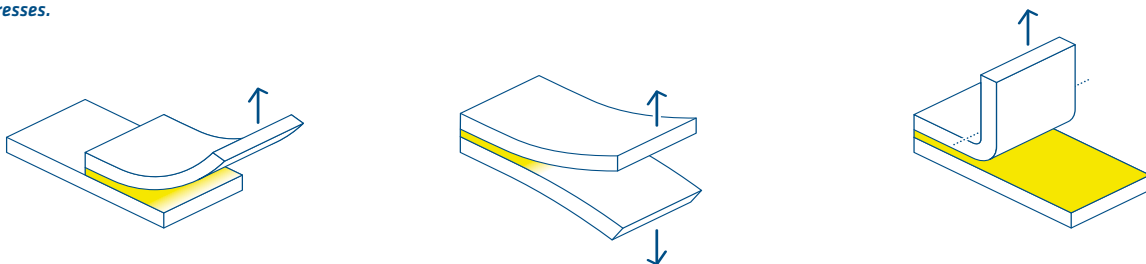

## Bonding PEEK

Material / preliminary treatment	Compressive strength in accordance with Delo Standard 5		Summary
	Strength	Strength	
<b>PEEK / PEEK</b> Cleaning with Delothen EP	10 MPa	+	<b>PEEK / PEEK bonding</b> Good strength levels with DELOMONOPOX adhesives; marked increase of strength levels due to plasma treatment or sand blasting
<b>PEEK / PEEK</b> Atmospheric pressure plasma	23 MPa	++	
<b>PEEK / PEEK</b> Sand blasted	25 MPa	++	
<b>PEEK / aluminium</b> Cleaning with Delothen EP	4 MPa	0	<b>PEEK aluminium bonding</b> Without preliminary treatment, low strength levels with DELOMONOPOX glues; very good strength levels after plasma treatment or sand blasting
<b>PEEK / aluminium</b> PEEK: Atmospheric pressure plasma	21 MPa	++	
<b>PEEK / aluminium</b> PEEK: Sand blasted	22 MPa	++	
<b>PEEK / steel</b> PEEK: Cleaning with Delothen EP	3.5 MPa	0	<b>PEEK-steel bonding</b> Without preliminary treatment, low strength levels with DELOMONOPOX glues; very good strength levels after sand blasting
<b>PEEK / steel</b> PEEK: Sand blasted	21 MPa	++	

++ very good strength + good strength 0 low strength

Source: DELO Industrieklebstoffe

The following manufacturers  
offer adhesives for engineering  
and high-performance plastics:

### DELO Industrieklebstoffe GmbH & Co. KG

DELO-Allee 1  
86949 Windach  
Tel. 08193 9900 131  
Fax 08193 9900 185  
www.delo.de

### 3M Deutschland GmbH

Carl-Schurz-Str. 1  
41453 Neuss  
Tel. 02131 14 0  
www.3Mdeutschland.de

### Henkel Loctite Deutschland GmbH

Arabellastraße 17  
81925 München  
Tel. 089 9268 0  
Fax 089 9101978  
www.loctite.com

### Dymax Europe GmbH

Trakehner Straße 3  
60487 Frankfurt  
Tel. 069 7165 3568  
Fax 069 7165 3830  
www.dymax.de

## General adhesive recommendations

Ensinger designation	Polymer designation	Solvent adhesive	Reaction adhesive on the basis of ...		
			Epoxy resin	Polyurethane	Cyanoacrylate
TECAFINE PE	PE		X	X	
TECAFINE PP	PP		X	X	
TECAFORM AD	POM-H	X		X	
TECAFORM AH	POM-C	X		X	
TECAMID 66	PA 66	X	X	X	X
TECAMID 6	PA 6	X	X	X	X
TECADUR PBT	PBT		X	X	X
TECAPET	PET		X	X	X
TECANAT	PC	X	X	X	X
TECAFLON PVDF	PVDF	X	X		X
TECASON S	PSU	X	X	X	X
TECASON P	PPSU	X	X	X	X
TECASON E	PES		X	X	X
TECATRON	PPS		X	X	X
TECAPEEK	PEEK		X	X	X
TECASINT	PI		X	X	X

X Suitable adhesives

### Materials which are not suitable or only conditionally suitable for bonding:

TECAFLON PTFE, TECAFLON PVDF, TECAFORM AH / AD,  
TECAFINE PE, TECAFINE PP / TECAPRO MT

# Cleaning plastics

According to DIN 8592, cleaning is a chemical process used in manufacturing to remove residues.

## The four factors relevant to cleaning

### Chemical

- Type of cleaning
- Cleaning chemical
- Concentration

### Mechanical

- Ultrasound
- Flow mechanism
- Spraying
- Brushing
- Geometry adjustment

### Temperature

- Cleaning temperature
- Rinsing temperature
- Drying temperature

### Time

- Cleaning time
- Rinsing time
- Drying time

Depending on the type of soiling, the relevant areas have to be adapted in order to achieve adequate cleanliness. Every process must be taken in context with the input parameters (material, geometry, contamination) and the output parameters (cleanliness requirement)

Process is influenced by:

- Contamination  
(film, particulate, coating, germs)
- Component geometry  
(bulk material, single part, scooping, functional surface)
- Component material (plastic)
- Requirements  
(rough cleaning, cleaning, precision cleaning, ultra-precision cleaning)

The following cleaning methods are particularly suitable for plastic cleaning:

### Wet chemical methods

- Also suitable for components with ultra-complex component geometries
- Usable for most plastics
- No abrasive influence on components
- Caution in the case of materials which absorb moisture (PA), due to tolerances
- Caution in the case of materials sensitive to stress cracking (amorphous) such as PC, PSU, PPSU etc.

### Mechanical processes

- Primarily suitable for the rough cleaning of plastics (brushing, wiping, ...)
- Caution with soft plastics due to possible surface damage (scratching)

### CO<sub>2</sub> snow - dry ice blasting

- Very suitable, as blasted material is subjected to practically no damage or influence.
- The process is dry, non-abrasive and does not result in transfer of heat to the component.
- Ideally suited also for soft materials and materials with high moisture absorbing properties (PTFE, PA, ...)

### Plasma method

- Suitable for components with ultra-complex component geometries
- Simultaneously exerts an activating effect on the plastic surface
- No abrasive influence on the surface, no humidity in the system

---

### **Situation in the food and medical technology sector**

#### *Problem issue:*

- For these sectors, to date no definition exists of which maximum residual contamination may be present on a component
- No parts with a defined level of cleanliness
- Individual producers must set out / define their own limiting values for admissible contamination
- The FDA and EU guidelines define directives and regulations on the migration of substances into products, but not on the degree of soiling

#### *Solution:*

- Manual definition of limiting values for admissible soiling
- Blank value cleaning
- Semi-finished products from Ensinger:
  - ↳ Biocompatibility tests are performed on semi-finished products for the medical technology sector. These provide a statement regarding suitability for bodily contact
  - ↳ Semi-finished products for food contact are tested for the migration behaviour of certain materials
  - ↳ Cooling lubricants in conformity with food regulations are used for grinding
  - ↳ Ensinger works in compliance with the GMP regulations for the food sector

---

### **Summary**

- Individual customers are required to set up their own definition of technical cleanliness
- Technical cleanliness can only be measured and assessed at the finished component following completion of all machining and cleaning steps
- As far as possible and feasible, semi-finished products from Ensinger comply with sector-specific cleanliness criteria:
  - ↳ Production in compliance with cleanliness requirements
  - ↳ Use of special cooling lubricants
  - ↳ Cytotoxicity tests for semi-finished products suitable for use in medical applications
  - ↳ Migration tests for semi-finished products suitable for use in food applications
  - ↳ Packaging for semi-finished products suitable for medical applications

**Do you have any other questions?**

**Our technical application advisory service  
will be pleased to help:  
[techservice.shapes@de.ensinger-online.com](mailto:techservice.shapes@de.ensinger-online.com)  
or by telephone on Tel. +49 7032 819-101 / -116**

# Product handling

**Ensinger plastics are used as the raw material for a wide range of high-quality components and end products in fields such as the food industry and medical technology, as well as mechanical and automotive engineering, semi-conductor technology and in the aerospace industry. To maintain the high standard of quality and functionality in our materials for these applications also over extended storage periods, certain factors must be taken into consideration in the storage, treatment and handling of Ensinger semi-finished products. By taking these precautions, it is possible to ensure that external influences are unable to significantly diminish the material properties. In the case of finished parts, the individual manufacturer or user is required to submit an individual confirmation of this, as conditions can differ considerably depending on the storage or utilization period.**

1. Storage and handling should take place in such a way that the material designations and product numbers (batch number) are clearly recognizable on the semi-finished products and can be maintained. This allows clear identification and traceability of products in the event of a possible complaint, allowing the possible root cause of the problem to be determined.

2. Weathering effects can impact on the properties of plastics. As result of the impact of solar radiation (UV radiation), atmospheric oxygen and moisture (precipitation, humidity) can exert a lasting negative impact on material characteristics. These influences can result in colour changes, oxidation of surfaces, swelling, warping, brittleness or even a change in mechanical properties. For this reason, semi-finished products should not be exposed to direct sunlight or the effects of weather over protracted periods.

If possible, the semi-finished products should be stored in closed rooms under normal climatic conditions (23 °C / 50 %rH).

The following materials in particular should be protected against the influence of the weather:

- TECAPEEK (PEEK)\*
- TECATRON (PPS)\*
- TECASON P (PPSU)\*
- TECASON S (PSU)\*
- TECASON E (PES)\*
- TECAFORM AH, AD (POM-C, POM-H)\*\*
- TECAPET (PET)\*\*
- TECAMID 6, 66, 11, 12, 46 (PA 6, 66, 11, 12, 46)\*\*
- TECAST (PA 6 C)\*\*
- TECAFINE (PE, PP)\*\*
- TECARAN ABS (ABS)\*

\* All variations should be generally protected

\*\* Variants not dyed black should be protected

3. Wherever possible, plastics should not be exposed to low temperatures over long periods. In particular, marked fluctuations in temperature should be avoided, as this can cause semi-finished products to warp or become brittle. Hard knocks and equally throwing or dropping should be avoided, as otherwise cracks and fracture damage can occur. In addition, semi-finished products stored in cold conditions should be allowed sufficient time to acclimatize to room temperature before processing. This can help to prevent defects such as cavities occurring during processing. It will also help to compensate for shrinkage or also elongation after exposure to hot atmospheres caused by the high coefficient of linear thermal expansion of plastics.

In order to store finished and semi-finished products for high levels of manufacturing precision, we consequently recommend storage under constant conditions in a normal climate (23 °C / 50 %rH). This allows external influences to be minimized and dimensional stability to be maintained over long periods.

It is not possible to specify a maximum storage period, as this depends heavily on the materials, storage conditions and external influences.



4. Semi-finished products made of plastic should consequently always be stored flat or on a suitable support (in the case of rods and tubes) and with the greatest possible surface contact in order to avoid deformation through their own intrinsic weight or warmth.

5. When handling plastic semi-finished products, ensure that suitable warehousing equipment is used. Ensure that storage facilities, lifting gear, slings and other lifting equipment are stable and secure. Stock shapes must also be stored and stacked so as to eliminate any danger of tipping or falling. Bear in mind here that plastics often have a relatively low coefficient of friction and are consequently easily able to slip out of load suspension devices, with the possibility of serious injury to staff members.

6. Avoid the effects of high-energy radiation such as gamma or X-rays wherever possible due to possible microstructure damage through molecular breakdown.

7. Plastic stock shapes should be kept away from all kinds of chemicals and water in order to prevent possible chemical attack or the absorption of moisture. Contact with chemicals or water can result in swelling, chemical decomposition or stress crack formation.

8. Plastics are organic materials and consequently combustible. The combustion or decomposition products may have a toxic or corrosive effect. If correctly stored, plastics themselves do not pose a fire risk. However, they should not be stored together with other combustible substances. On this subject, observe the product handling information sheets for the individual materials.

9. Under normal conditions, plastic semi-finished or finished products do not release any toxic constituents and permit risk-free surface contact.

Tobacco products should not be allowed in the vicinity when handling and machining plastics, as particles of some plastics (in particular fluoropolymers) can release strong toxic gases in some cases during pyrolyzation of the smouldering tobacco. In respect of health protection, please also note the product handling information sheets for the individual materials.

10. If the above recommendations are adhered to, it may be assumed that no significant changes to typical properties will occur during the storage period. It is possible that minimal surface discolouration may occur due to environmental influences. However, this does not represent any significant deterioration of material properties, as the surface is generally only affected down to a few microns in depth.

11. Plastic waste and chips can be processed and recycled by professional recycling companies. It is also possible to send the waste for thermal processing to generate energy by a professional company in a combustion plant with a suitable emission control in place. This applies in particular to applications where the plastic waste produced is contaminated, e.g. in the case of machining chips contaminated with oil.

These recommendations should be adjusted expediently in line with individual requirements and circumstances.

They do not replace the fundamentally applicable statutory regulations, or exonerate customers using the products from their responsibility or individuals from their duty of care. These are merely intended as recommendations drawn up on the basis of current knowledge. They do not constitute any generally applicable assurance.

# Material standard values

Material		TECARAN ABS grey	TECANYL MT coloured	TECANYL GF30	TECANYL 731 grey	TECAFINE PMP	TECAPRO MT	TECAFORM AH natural	TECAFORM AH black	TECAFORM AH GF25	TECAFORM AH ELS
Chemical Designation		ABS	PPE	PPE	PPE	PMP	PP	POM-C	POM-C	POM-C	POM-C
Fillers				glass fibres			heat stabilized			glass fibres	conductive carbon black
Density (DIN EN ISO 1183)	[g / cm <sup>3</sup> ]	1.04	1.04 - 1.10	1.3	1.1	0.83	0.93	1.41	1.41	1.59	1.41
<b>Mechanical properties</b>											
Modulus of elasticity (tensile test) (DIN EN ISO 527-2)	[MPa]	1,700	2,400	4,100	2,400	1,000	2,000	2,800	2,800	4,200	1,800
Tensile strength (DIN EN ISO 527-2)	[MPa]	32	65	73	57	26	34	67	67	51	42
Tensile strength at yield (DIN EN ISO 527-2)	[MPa]	32	67	73	57	26	34	67	67	51	42
Elongation at yield (DIN EN ISO 527-2)	[%]	3	4	5	15	6	5	9	9	9	11
Elongation at break (DIN EN ISO 527-2)	[%]	49	8	5	22	67	67	32	32	12	11
Modulus of elasticity (flexural test) (DIN EN ISO 178)	[MPa]	1,600	2,400	3,900	2,500	800	1,800	2,600	2,600	4,100	1,500
Flexural strength (DIN EN ISO 178)	[MPa]	49	95	116	85	31	54	91	91	88	56
Compression modulus (EN ISO 604)	[MPa]	1,400	2,100	3,300	2,100	1,000	1,600	2,300	2,300	3,600	1,500
Compressive strength (1% / 2%) (EN ISO 604)	[MPa]	15 / 26	17 / 30	23 / 41	18 / 33	11 / 19	16 / 26	20 / 35	20 / 35	23 / 39	16 / 25
Impact strength (Charpy) (DIN EN ISO 179-1eU)	[kJ / m <sup>2</sup> ]	n.b.	70	37	69	17	140	n.b.	150	36	74
Notched impact strength (Charpy) (DIN EN ISO 179-1eA)	[kJ / m <sup>2</sup> ]	34						8	6		
Ball indentation hardness (ISO 2039-1)	[MPa]	74	140	205	146	58	100	165	165	180	96
<b>Thermal properties</b>											
Glass transition temperature (DIN 53765)	[°C]	104	174	150	145		-10	-60	-60	-60	-60
Melting temperature (DIN 53765)	[°C]		n.a.	n.a.	n.a.		165	166	166	170	169
Service temperature, short term	[°C]	100	110	110	110	170	140	140	140	140	140
Service temperature, long term	[°C]	75	95	85	85	120	100	100	100	100	100
Thermal expansion (CLTE), 23 - 60 °C (DIN EN ISO 11359-1;2)	[10 <sup>-5</sup> K <sup>-1</sup> ]		8	4	8		13	13	13	8	13
Thermal expansion (CLTE), 23 - 100 °C (DIN EN ISO 11359-1;2)	[10 <sup>-5</sup> K <sup>-1</sup> ]		8	4	8		14	14	14	8	14
Specific heat (ISO 22007-4:2008)	[J / (g*K)]		1.3	1.2	1.3			1.4	1.4	1.2	1.3
Thermal conductivity (ISO 22007-4:2008)	[W / (m*K)]		0.21	0.28	0.21			0.39	0.39	0.47	0.46
<b>Electrical properties</b>											
Surface resistance (DIN IEC 60093)	[Ω]		10 <sup>14</sup>	10 <sup>14</sup>	10 <sup>13</sup>		10 <sup>14</sup>	10 <sup>14</sup>	10 <sup>12</sup>	10 <sup>14</sup>	10 <sup>4</sup>
<b>Miscellaneous data</b>											
Water absorption 24h / 96h (23 °C) (DIN EN ISO 62)	[%]	0.07 / 0.2	0.02 / 0.04	0.01 / 0.02	0.02 / 0.04	<0.01 / <0.01	0.01 / 0.02	0.05 / 0.1	0.05 / 0.1	0.07 / 0.2	0.05 / 0.2
Resistance to hot water / bases		-	(+)	(+)	(+)	(+)	(+)	(+)	(+)	(+)	(+)
Resistance to weathering		-	-	-	-	-	-	-	(+)	-	(+)
Flammability (UL94) (DIN IEC 60695-11-10:)		HB	HB	HB	HB	HB	HB	HB	HB	HB	HB

Data generated directly after machining (standard climate Germany). For polyamides the values strongly depend on the humidity content.



Test specimen to DIN EN ISO 527-2

+ good resistance  
 (+) limited resistance  
 - poor resistance (depending on concentration, time and temperature)  
 n.b. not broken  
 n.a. not applicable

(a) Glass transition temperature testing according to DIN EN ISO 11357  
 (b) Thermal conductivity testing according to ISO 8302  
 (c) Thermal conductivity testing according to ASTM E1530  
 (d) Surface resistance testing according to ASTM D 257

Material		TECAFORM AH SD	TECAFORM AH ID	TECAFORM AH LA blue	TECAFORM AH SAN	TECAFORM AH MT coloured	TECAFORM AD	TECAFORM AD black	TECAFORM AD AF	TECAST T	TECAST TM
Chemical Designation		POM-C	POM-C	POM-C	POM-C	POM-C	POM-H	POM-H	POM-H	PA 6 C	PA 6 C
Fillers		antistatic agent	detectable filler	solid lubricant	antimicrobial				PTFE		molyb- denum disulfide
Density (DIN EN ISO 1183)	[g / cm <sup>3</sup> ]	1.35	1.49	1.36	1.41	1.41	1.43	1.43	1.49	1.15	1.15
<b>Mechanical properties</b>											
Modulus of elasticity (tensile test) (DIN EN ISO 527-2)	[MPa]	1,300	3,200	2,100	2,900	2,800	3,400	3,600	3,000	3,500	3,200
Tensile strength (DIN EN ISO 527-2)	[MPa]	39	68	48	67	69	79	80	53	83	82
Tensile strength at yield (DIN EN ISO 527-2)	[MPa]	39	68	48	69	70	79	80	53	80	80
Elongation at yield (DIN EN ISO 527-2)	[%]	23	8	9	7	15	37	32	8	4	4
Elongation at break (DIN EN ISO 527-2)	[%]	23	10	9	18	30	45	43	8	55	55
Modulus of elasticity (flexural test) (DIN EN ISO 178)	[MPa]	1,200	3,100	2,000	2,800	2,800	3,600	3,600	3,000	3,200	3,000
Flexural strength (DIN EN ISO 178)	[MPa]	46	100	70	93	94	106	106	85	109	102
Compression modulus (EN ISO 604)	[MPa]	1,100	2,400	1,800	2,200	2,200	2,700	2,800	2,400	2,900	2,800
Compressive strength (1% / 2%) (EN ISO 604)	[MPa]	12 / 19	17 / 31	16 / 27	18 / 31	18 / 32	19 / 33	22 / 38	19 / 33	19 / 36	22 / 38
Impact strength (Charpy) (DIN EN ISO 179-1eU)	[kJ / m <sup>2</sup> ]	n.b.	59	27	102	n.b.	n.b.	n.b.	n.b.	n.b.	n.b.
Notched impact strength (Charpy) (DIN EN ISO 179-1eA)	[kJ / m <sup>2</sup> ]	9	11			9	15	14	25	4	4
Ball indentation hardness (ISO 2039-1)	[MPa]	74	174	120	163	158	185	185	166	170	170
<b>Thermal properties</b>											
Glass transition temperature (DIN 53765)	[°C]	-60	-60	-60	-60	-60	-60	-60	-60	40	43
Melting temperature (DIN 53765)	[°C]	165	169	166	166	169	182	182	179	215	217
Service temperature, short term	[°C]	140	140	140	140	140	150	150	150	170	170
Service temperature, long term	[°C]	100	100	100	100	100	110	110	110	100	100
Thermal expansion (CLTE), 23 - 60 °C (DIN EN ISO 11359-1;2)	[10 <sup>-5</sup> K <sup>-1</sup> ]	16	13	13	13	13	12	11	12	12	11
Thermal expansion (CLTE), 23 - 100 °C (DIN EN ISO 11359-1;2)	[10 <sup>-5</sup> K <sup>-1</sup> ]	17	14	14	14	14	13	11	13	12	11
Specific heat (ISO 22007-4:2008)	[J / (g*K)]	1.6	1.3	1.4	1.4	1.4	1.3	1.3	1.3	1.7	1.6
Thermal conductivity (ISO 22007-4:2008)	[W / (m*K)]	0.30	0.39	0.39	0.39	0.39	0.43	0.43	0.46	0.38	0.33
<b>Electrical properties</b>											
Surface resistance (DIN IEC 60093)	[Ω]	10 <sup>11</sup>	10 <sup>13</sup>	10 <sup>14</sup>		10 <sup>12</sup>	10 <sup>14</sup>	10 <sup>12</sup>	10 <sup>14</sup>	10 <sup>14</sup>	10 <sup>12</sup>
<b>Miscellaneous data</b>											
Water absorption 24h / 96h (23 °C) (DIN EN ISO 62)	[%]	0.9 / 1.8	0.05 / 0.1	0.05 / 0.1	0.05 / 0.1	0.05 / 0.1	0.05 / 0.1	0.05 / 0.1	0.05 / 0.1	0.2 / 0.4	0.2 / 0.5
Resistance to hot water / bases	(+)	(+)	(+)	(+)	(+)	(+)	-	-	-	(+)	(+)
Resistance to weathering	-	-	-	-	-	-	-	-	-	-	(+)
Flammability (UL94) (DIN IEC 60695-11-10:)		HB	HB	HB	HB	HB	HB	HB	HB	HB	HB

The corresponding values and information are no minimum or maximum values, but guideline values that can be used primarily for comparison purposes for material selection. These values are within the normal tolerance range of product properties and do not represent guaranteed property values. Therefore they shall not be used for specification purposes. Unless otherwise noted, these values were

determined by tests at reference dimensions (typically rods with diameter 40-60 mm according to DIN EN 15860) on extruded, cast, compression moulded and machined specimens. As the properties depend on the dimensions of the semi-finished products and the orientation in the component (esp. in reinforced grades), the material may not be used without separate testing under individual circumstances.

Data sheet values are subject to periodic review, the most recent update can be found at [www.ensinger-online.com](http://www.ensinger-online.com)

Technical changes reserved.

# Material standard values

Material		TECAST L	TECAST L black	TECAST L yellow	TECAGLIDE green	TECARIM 1500 yellow	TECAMID 6	TECAM 6 MO	TECAMID 6 GF25 black	TECAMID 6 GF30 black	TECAMID 66
Chemical Designation		PA 6 C	PA 6 C	PA 6 C	PA 6 C	PA 6 C	PA 6	PA 6	PA 6	PA 6	PA 66
Fillers		oil	oil	oil	solid lubricant	elastomer		molybdenum disulfide	glass fibres	glass fibres	
Density (DIN EN ISO 1183)	[g / cm <sup>3</sup> ]	1.13	1.14	1.14	1.13	1.11	1.14	1.14	1.33	1.36	1.15
<b>Mechanical properties</b>											
Modulus of elasticity (tensile test) (DIN EN ISO 527-2)	[MPa]	2,900	3,100	3,100	3,200	2,200	3,300	3,300	5,100	5,700	3,500
Tensile strength (DIN EN ISO 527-2)	[MPa]	69	70	70	76	53	79	84	96	98	85
Tensile strength at yield (DIN EN ISO 527-2)	[MPa]	66	68	68	76	53	78	82	96	98	84
Elongation at yield (DIN EN ISO 527-2)	[%]	8	4	4	14	13	4	5	9	4	7
Elongation at break (DIN EN ISO 527-2)	[%]	50	50	50	18	58	130	37	11	5	70
Modulus of elasticity (flexural test) (DIN EN ISO 178)	[MPa]	2,900	2,900	2,900	3,100	2,200	2,900	3,100	4,900	5,200	3,100
Flexural strength (DIN EN ISO 178)	[MPa]	95	95	95	103	73	100	110	143	140	110
Compression modulus (EN ISO 604)	[MPa]	2,700	2,700	2,700	2,500	2,100	2,700	2,900	3,900	4,200	2,700
Compressive strength (1% / 2%) (EN ISO 604)	[MPa]	19 / 35	21 / 37	21 / 37	18 / 34	14 / 26	24 / 41	17 / 32	21 / 42	21 / 42	20 / 35
Impact strength (Charpy) (DIN EN ISO 179-1eU)	[kJ / m <sup>2</sup> ]	n.b.	n.b.	n.b.	n.b.	n.b.	n.b.	n.b.	78	60	n.b.
Notched impact strength (Charpy) (DIN EN ISO 179-1eA)	[kJ / m <sup>2</sup> ]	5	5	6	4	16	7	5			5
Ball indentation hardness (ISO 2039-1)	[MPa]	150	150	150	159	95	155	160	230	232	175
<b>Thermal properties</b>											
Glass transition temperature (DIN 53765)	[°C]	48	42	42	45	53	45	51	49	49	47
Melting temperature (DIN 53765)	[°C]	218	216	216	218	216	221	220	217	218	258
Service temperature, short term	[°C]	170	170	170	130	160	160	160	180	180	170
Service temperature, long term	[°C]	100	100	100	100	95	100	100	100	100	100
Thermal expansion (CLTE), 23 – 60 °C (DIN EN ISO 11359-1;2)	[10 <sup>-5</sup> K <sup>-1</sup> ]	13	13	13	11	13	12	8	7	6	11
Thermal expansion (CLTE), 23 – 100 °C (DIN EN ISO 11359-1;2)	[10 <sup>-5</sup> K <sup>-1</sup> ]	13	13	13	12	13	13	8	8	6	12
Specific heat (ISO 22007-4:2008)	[J / (g*K)]	1.7	1.7	1.7	1.7	1.7	1.6	1.6	1.4	1.3	1.5
Thermal conductivity (ISO 22007-4:2008)	[W / (m*K)]	0.37	0.37	0.37	0.38	0.32	0.37	0.37	0.40	0.41	0.36
<b>Electrical properties</b>											
Surface resistance (DIN IEC 60093)	[Ω]	10 <sup>14</sup>	10 <sup>12</sup>	10 <sup>14</sup>	10 <sup>14</sup>	10 <sup>14</sup>	10 <sup>14</sup>	10 <sup>12</sup>	10 <sup>12</sup>	10 <sup>12</sup>	10 <sup>14</sup>
<b>Miscellaneous data</b>											
Water absorption 24h / 96h (23 °C) (DIN EN ISO 62)	[%]	0.2 / 0.4	0.2 / 0.4	0.2 / 0.4	0.2 / 0.3	0.6 / 1.2	0.3 / 0.6	0.3 / 0.6	0.2 / 0.3	0.2 / 0.3	0.2 / 0.4
Resistance to hot water / bases		(+)	(+)	(+)	(+)	(+)	(+)	(+)	(+)	(+)	(+)
Resistance to weathering		-	(+)	-	-	-	-	(+)	(+)	(+)	-
Flammability (UL94) (DIN IEC 60695-11-10:)		HB	HB	HB	HB	HB	HB	HB	HB	HB	HB

Data generated directly after machining (standard climate Germany). For polyamides the values strongly depend on the humidity content.

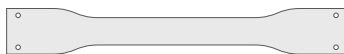

Test specimen to DIN EN ISO 527-2

+ good resistance  
 (+) limited resistance  
 - poor resistance (depending on concentration, time and temperature)  
 n.b. not broken  
 n.a. not applicable

(a) Glass transition temperature testing according to DIN EN ISO 11357  
 (b) Thermal conductivity testing according to ISO 8302  
 (c) Thermal conductivity testing according to ASTM E1530  
 (d) Surface resistance testing according to ASTM D 257

Material		TECAMID 66 MH	TECAMID 66 GF30 black	TECAMID 66 CF20	TECAMID 66 HI	TECAMID 66 LA	TECAMID 66/X GF50 black	TECAMID 46 redbrown	TECAMID 12	TECAPET	TECAPET black
Chemical Designation		PA 66	PA 66	PA 66	PA 66	PA 66	PA 66	PA 46	PA 12	PET	PET
Fillers		molybdenum disulfide	glass fibres	carbon fibres	heat stabilized	lubricant	glass fibres				
Density (DIN EN ISO 1183)	[g / cm <sup>3</sup> ]	1.15	1.34	1.23	1.15	1.11	1.61	1.19	1.02	1.36	1.39
<b>Mechanical properties</b>											
Modulus of elasticity (tensile test) (DIN EN ISO 527-2)	[MPa]	3,200	5,500	5,100	3,400	3,100	8,700	3,300	1,800	3,100	3,400
Tensile strength (DIN EN ISO 527-2)	[MPa]	84	91	104	89	76	115	106	53	79	91
Tensile strength at yield (DIN EN ISO 527-2)	[MPa]	83	91	104	72	76	115	106	54	79	91
Elongation at yield (DIN EN ISO 527-2)	[%]	10	8	12	7	11	2	21	9	5	4
Elongation at break (DIN EN ISO 527-2)	[%]	40	14	13	25	14	2	32	200	10	15
Modulus of elasticity (flexural test) (DIN EN ISO 178)	[MPa]	3,100	4,700	4,300	3,300	2,800	9,000	3,300	1,700	3,200	3,400
Flexural strength (DIN EN ISO 178)	[MPa]	114	135	135	112	102	200	132	68	121	134
Compression modulus (EN ISO 604)	[MPa]	2,700	4,100	3,800	2,900	2,400	6,200	2,800	1,600	2,700	2,800
Compressive strength (1% / 2%) (EN ISO 604)	[MPa]	20 / 38	25 / 46	16 / 33	14 / 29	20 / 35	28 / 56	20 / 35	13 / 24	19 / 35	19 / 36
Impact strength (Charpy) (DIN EN ISO 179-1eU)	[kJ / m <sup>2</sup> ]	n.b.	97	116	n.b.	37		n.b.	n.b.	81	27
Notched impact strength (Charpy) (DIN EN ISO 179-1eA)	[kJ / m <sup>2</sup> ]	5			5			9	7	4	
Ball indentation hardness (ISO 2039-1)	[MPa]	168	216	200	191	145		187	105	175	195
<b>Thermal properties</b>											
Glass transition temperature (DIN 53765)	[°C]	52	48	48	57	54	78	72	37	81	81
Melting temperature (DIN 53765)	[°C]	253	254	251	263	261	256	299	180	244	244
Service temperature, short term	[°C]	170	170	170	180	120	200	220	150	170	170
Service temperature, long term	[°C]	100	110	100	115	90	130	130	110	110	110
Thermal expansion (CLTE), 23 – 60 °C (DIN EN ISO 11359-1;2)	[10 <sup>-5</sup> K <sup>-1</sup> ]	10	5	9	12	11		13	15	8	8
Thermal expansion (CLTE), 23 – 100 °C (DIN EN ISO 11359-1;2)	[10 <sup>-5</sup> K <sup>-1</sup> ]	10	5	10	12	12		13	16	10	10
Specific heat (ISO 22007-4:2008)	[J / (g*K)]	1.5	1.2	1.4	1.5	1.6		1.7	1.8		
Thermal conductivity (ISO 22007-4:2008)	[W / (m*K)]	0.36	0.39	0.72	0.36	0.36		0.37	0.30		
<b>Electrical properties</b>											
Surface resistance (DIN IEC 60093)	[Ω]	10 <sup>12</sup>	10 <sup>12</sup>	10 <sup>8</sup>	10 <sup>14</sup>	10 <sup>14</sup>	10 <sup>12</sup>	10 <sup>13</sup>	10 <sup>14</sup>	10 <sup>14</sup>	10 <sup>12</sup>
<b>Miscellaneous data</b>											
Water absorption 24h / 96h (23 °C) (DIN EN ISO 62)	[%]	0.2 / 0.4	0.1 / 0.2	0.1 / 0.3	0.2 / 0.3	0.2 / 0.4	0.1 / 0.2	0.4 / 0.7	0.04 / 0.07	0.02 / 0.03	0.02 / 0.03
Resistance to hot water / bases	(+)	(+)	(+)	(+)	(+)	(+)	-	(+)	+	-	-
Resistance to weathering	(+)	(+)	(+)	-	-	-	(+)	-	-	-	(+)
Flammability (UL94) (DIN IEC 60695-11-10:)		HB	HB	HB	HB	HB	HB	V2	HB	HB	HB

The corresponding values and information are no minimum or maximum values, but guideline values that can be used primarily for comparison purposes for material selection. These values are within the normal tolerance range of product properties and do not represent guaranteed property values. Therefore they shall not be used for specification purposes. Unless otherwise noted, these values were

determined by tests at reference dimensions (typically rods with diameter 40-60 mm according to DIN EN 15860) on extruded, cast, compression moulded and machined specimens. As the properties depend on the dimensions of the semi-finished products and the orientation in the component (esp. in reinforced grades), the material may not be used without separate testing under individual circumstances.

Data sheet values are subject to periodic review, the most recent update can be found at [www.ensinger-online.com](http://www.ensinger-online.com)

Technical changes reserved.

# Material standard values

Material		TECAPET TF	TECADUR PET	TECADUR PBT GF30	TECANAT	TECANAT GF30	TECAFLON PVDF	TECASON S	TECAPEI	TECASON P white	TECASON P MT coloured
Chemical Designation		PET	PET	PBT	PC	PC	PVDF	PSU	PEI	PPSU	PPSU
Fillers		solid lubricant		glass fibres		glass fibres					
Density (DIN EN ISO 1183)	[g / cm <sup>3</sup> ]	1.43	1.39	1.46	1.19	1.42	1.78	1.24	1.28	1.31	1.31
<b>Mechanical properties</b>											
Modulus of elasticity (tensile test) (DIN EN ISO 527-2)	[MPa]	3,200	3,300	3,400	2,200	4,400	2,200	2,700	3,200	2,300	2,300
Tensile strength (DIN EN ISO 527-2)	[MPa]	78	91	46	69	85	62	89	127	81	81
Tensile strength at yield (DIN EN ISO 527-2)	[MPa]	78	91	46	69	87	62	89	127	81	81
Elongation at yield (DIN EN ISO 527-2)	[%]	4	4	5	6	4	8	5	7	7	7
Elongation at break (DIN EN ISO 527-2)	[%]	6	14	6	90	6	17	15	35	50	50
Modulus of elasticity (flexural test) (DIN EN ISO 178)	[MPa]	3,300	3,400	3,400	2,300	4,500	2,100	2,600	3,300	2,300	2,300
Flexural strength (DIN EN ISO 178)	[MPa]	119	134	78	97	138	77	122	164	107	107
Compression modulus (EN ISO 604)	[MPa]	2,700	2,800	2,800	2,000	3,300	1,900	2,300	2,800	2,000	2,000
Compressive strength (1% / 2%) (EN ISO 604)	[MPa]	21 / 38	21 / 38	20 / 38	16 / 29	21 / 39	16 / 28	15 / 28	23 / 41	18 / 30	18 / 30
Impact strength (Charpy) (DIN EN ISO 179-1eU)	[kJ / m <sup>2</sup> ]	42	150	37	n.b.	71	150	175	113	n.b.	n.b.
Notched impact strength (Charpy) (DIN EN ISO 179-1eA)	[kJ / m <sup>2</sup> ]				14			4		13	13
Ball indentation hardness (ISO 2039-1)	[MPa]	183	194	190	128	190	129	167	225	143	143
<b>Thermal properties</b>											
Glass transition temperature (DIN 53765)	[°C]	82	81		149	147	-40	188	216	218	218
Melting temperature (DIN 53765)	[°C]	249	244	224	n.a.	n.a.	171	n.a.	n.a.	n.a.	n.a.
Service temperature, short term	[°C]	170	170	200	140	140	150	180	200	190	190
Service temperature, long term	[°C]	110	110	110	120	120	150	160	170	170	170
Thermal expansion (CLTE), 23 - 60 °C (DIN EN ISO 11359-1;2)	[10 <sup>-5</sup> K <sup>-1</sup> ]	8	8	8	8	5	16	6	5	6	6
Thermal expansion (CLTE), 23 - 100 °C (DIN EN ISO 11359-1;2)	[10 <sup>-5</sup> K <sup>-1</sup> ]	10	10	10	8	5	18	6	5	6	6
Specific heat (ISO 22007-4:2008)	[J / (g*K)]			1.2	1.3	1.1	1.3	1.2	1.2	1.1	1.1
Thermal conductivity (ISO 22007-4:2008)	[W / (m*K)]			0.33	0.25	0.32	0.25	0.21	0.21	0.25	0.25
<b>Electrical properties</b>											
Surface resistance (DIN IEC 60093)	[Ω]	10 <sup>14</sup>	10 <sup>14</sup>	10 <sup>14</sup>	10 <sup>14</sup>	10 <sup>14</sup>	10 <sup>14</sup>	10 <sup>14</sup>	10 <sup>14</sup>	10 <sup>14</sup>	10 <sup>12</sup>
<b>Miscellaneous data</b>											
Water absorption 24h / 96h (23 °C) (DIN EN ISO 62)	[%]	0.02 / 0.03	0.02 / 0.03	0.02 / 0.04	0.03 / 0.06	0.03 / 0.05	<0.01 / <0.01	0.06 / 0.1	0.05 / 0.1	0.1 / 0.2	0.1 / 0.2
Resistance to hot water / bases		-	-	-	-	-	+	+	+	+	+
Resistance to weathering		-	-	-	(+)	-	+	-	-	-	-
Flammability (UL94) (DIN IEC 60695-11-10:)		HB	HB	HB	HB	HB	V0	V0	V0	V0	V0

Data generated directly after machining (standard climate Germany). For polyamides the values strongly depend on the humidity content.



Test specimen to DIN EN ISO 527-2

+ good resistance  
 (+) limited resistance  
 - poor resistance (depending on concentration, time and temperature)  
 n.b. not broken  
 n.a. not applicable

(a) Glass transition temperature testing according to DIN EN ISO 11357  
 (b) Thermal conductivity testing according to ISO 8302  
 (c) Thermal conductivity testing according to ASTM E1530  
 (d) Surface resistance testing according to ASTM D 257

Material		TECATRON	TECATRON GF40	TECATRON GF40 black	TECATRON PVX	TECAPEEK	TECAPEEK black	TECAPEEK bright red	TECAPEEK GF30	TECAPEEK CF30	TECAPEEK PVX
Chemical Designation		PPS	PPS	PPS	PPS	PEEK	PEEK	PEEK	PEEK	PEEK	PEEK
Fillers			glass fibres	glass fibres	carbon fibres, PTFE, graphite				glass fibres	carbon fibres	carbon fibres, PTFE, graphite
Density (DIN EN ISO 1183)	[g / cm <sup>3</sup> ]	1.36	1.63	1.63	1.5	1.31	1.31	1.36	1.53	1.38	1.44
<b>Mechanical properties</b>											
Modulus of elasticity (tensile test) (DIN EN ISO 527-2)	[MPa]	4,100	6,500	6,500	4,600	4,200	4,100	4,200	6,400	6,800	5,500
Tensile strength (DIN EN ISO 527-2)	[MPa]	102	83	83	53	116	100	108	105	122	84
Tensile strength at yield (DIN EN ISO 527-2)	[MPa]	100	83	83	53	116	100	108	105	122	84
Elongation at yield (DIN EN ISO 527-2)	[%]	4	3	3	2	5	3	4	3	7	3
Elongation at break (DIN EN ISO 527-2)	[%]	4	3	3	2	15	3	6	3	7	3
Modulus of elasticity (flexural test) (DIN EN ISO 178)	[MPa]	4,000	6,600	6,600	4,800	4,200	4,100	4,500	6,600	6,800	6,000
Flexural strength (DIN EN ISO 178)	[MPa]	151	145	145	91	175	171	177	164	193	142
Compression modulus (EN ISO 604)	[MPa]	3,300	4,600	4,600	3,300	3,400	3,300	3,500	4,800	5,000	4,000
Compressive strength (1% / 2%) (EN ISO 604)	[MPa]	20 / 38	21 / 41	21 / 41	19 / 36	23 / 43	22 / 41	22 / 40	29 / 52	25 / 47	23 / 44
Impact strength (Charpy) (DIN EN ISO 179-1eU)	[kJ / m <sup>2</sup> ]	29	24	24	14	n.b.	75	50	33	62	28
Notched impact strength (Charpy) (DIN EN ISO 179-1eA)	[kJ / m <sup>2</sup> ]					4					
Ball indentation hardness (ISO 2039-1)	[MPa]				238	253	253	244	316	355	250
<b>Thermal properties</b>											
Glass transition temperature (DIN 53765)	[°C]	97	93	93	94	150	151	151	147	147	146
Melting temperature (DIN 53765)	[°C]	281	280	280	281	341	341	341	341	341	341
Service temperature, short term	[°C]	260	260	260	260	300	300	300	300	300	300
Service temperature, long term	[°C]	230	230	230	230	260	260	260	260	260	260
Thermal expansion (CLTE), 23 – 60 °C (DIN EN ISO 11359-1;2)	[10 <sup>-5</sup> K <sup>-1</sup> ]	6	4	4	5	5	5	5	4	4	3
Thermal expansion (CLTE), 23 – 100 °C (DIN EN ISO 11359-1;2)	[10 <sup>-5</sup> K <sup>-1</sup> ]	7	5	5	6	5	5	5	4	4	3
Specific heat (ISO 22007-4:2008)	[J / (g*K)]	1.0	1.0	0.9	0.9	1.1	1.1	1.1	1.0	1.2	1.1
Thermal conductivity (ISO 22007-4:2008)	[W / (m*K)]	0.25	0.35	0.33	0.58	0.27	0.30	0.27	0.35	0.66	0.82
<b>Electrical properties</b>											
Surface resistance (DIN IEC 60093)	[Ω]	10 <sup>14</sup>	10 <sup>14</sup>	10 <sup>12</sup>	10 <sup>8</sup>	10 <sup>14</sup>	10 <sup>12</sup>	10 <sup>14</sup>	10 <sup>14</sup>	10 <sup>8</sup>	10 <sup>8</sup>
<b>Miscellaneous data</b>											
Water absorption 24h / 96h (23 °C) (DIN EN ISO 62)	[%]	<0.01 / 0.01	<0.01 / 0.01	<0.01 / 0.01	<0.01 / 0.01	0.02 / 0.03	0.02 / 0.03	0.02 / 0.03	0.02 / 0.03	0.02 / 0.03	0.02 / 0.03
Resistance to hot water / bases		+	+	+	+	+	+	+	+	+	+
Resistance to weathering		-	-	(+)	(+)	-	-	-	-	-	-
Flammability (UL94) (DIN IEC 60695-11-10:)		V0	V0	V0	V0	V0	V0	V0	V0	V0	V0

The corresponding values and information are no minimum or maximum values, but guideline values that can be used primarily for comparison purposes for material selection. These values are within the normal tolerance range of product properties and do not represent guaranteed property values. Therefore they shall not be used for specification purposes. Unless otherwise noted, these values were

determined by tests at reference dimensions (typically rods with diameter 40-60 mm according to DIN EN 15860) on extruded, cast, compression moulded and machined specimens. As the properties depend on the dimensions of the semi-finished products and the orientation in the component (esp. in reinforced grades), the material may not be used without separate testing under individual circumstances.

Data sheet values are subject to periodic review, the most recent update can be found at [www.ensinger-online.com](http://www.ensinger-online.com)

Technical changes reserved.

# Material standard values

Material		TECAPEEK ELS nano	TECAPEEK TF10 blue	TECAPEEK ID	TECAPEEK MT	TECAPEEK MT black	TECAPEEK MT blue	TECAPEEK MT green	TECAPEEK MT yellow	TECAPEEK MT bright red	TECAPEEK MT ivory
Chemical Designation		PEEK	PEEK	PEEK	PEEK	PEEK	PEEK	PEEK	PEEK	PEEK	PEEK
Fillers		CNT	PTFE								
Density (DIN EN ISO 1183)	[g / cm <sup>3</sup> ]	1.36	1.38	1.49	1.31	1.31	1.34	1.32	1.38	1.36	1.42
<b>Mechanical properties</b>											
Modulus of elasticity (tensile test) (DIN EN ISO 527-2)	[MPa]	4,800	3,400	4,600	4,200	4,200	4,300	4,100	4,400	4,200	4,400
Tensile strength (DIN EN ISO 527-2)	[MPa]	106	95	111	116	114	113	116	113	108	114
Tensile strength at yield (DIN EN ISO 527-2)	[MPa]	106	95	111	116	114	113	116	113	108	114
Elongation at yield (DIN EN ISO 527-2)	[%]	4	5	4	5	5	5	5	5	4	4
Elongation at break (DIN EN ISO 527-2)	[%]	4	8	6	15	13	11	17	10	6	12
Modulus of elasticity (flexural test) (DIN EN ISO 178)	[MPa]	4,700	3,900	3,700	4,200	4,100	4,300	4,200	4,300	4,500	4,400
Flexural strength (DIN EN ISO 178)	[MPa]	178	149	166	175	171	173	172	169	177	171
Compression modulus (EN ISO 604)	[MPa]	3,600	3,000	4,800	3,400	3,400	3,400	3,400	3,400	3,500	3,400
Compressive strength (1% / 2%) (EN ISO 604)	[MPa]	27 / 47	22 / 39	25 / 46	23 / 43	23 / 44	17 / 35	17 / 35	17 / 35	22 / 40	24 / 44
Impact strength (Charpy) (DIN EN ISO 179-1eU)	[kJ / m <sup>2</sup> ]	58	48	72	n.b.	n.b.	n.b.	n.b.	n.b.	50	n.b.
Notched impact strength (Charpy) (DIN EN ISO 179-1eA)	[kJ / m <sup>2</sup> ]				4	5	7	4	5		4
Ball indentation hardness (ISO 2039-1)	[MPa]	253	220	260	253	243	248	250	257	244	250
<b>Thermal properties</b>											
Glass transition temperature (DIN 53765)	[°C]	147	157	150	150	151	151	151	151	151	150
Melting temperature (DIN 53765)	[°C]	341	340	341	342	341	341	341	341	341	340
Service temperature, short term	[°C]	300	300	300	300	300	300	300	300	300	300
Service temperature, long term	[°C]	260	260	260	260	260	260	260	260	260	260
Thermal expansion (CLTE), 23 – 60 °C (DIN EN ISO 11359-1;2)	[10 <sup>-5</sup> K <sup>-1</sup> ]	5	6	5	5	5	5	5	5	5	5
Thermal expansion (CLTE), 23 – 100 °C (DIN EN ISO 11359-1;2)	[10 <sup>-5</sup> K <sup>-1</sup> ]	5	6	5	5	5	5	5	5	5	5
Specific heat (ISO 22007-4:2008)	[J / (g*K)]	1.1		1.1	1.1	1.1	1.1	1.1	1.1	1.1	
Thermal conductivity (ISO 22007-4:2008)	[W / (m*K)]	0.46		0.27	0.27	0.3	0.28	0.28	0.28	0.27	
<b>Electrical properties</b>											
Surface resistance (DIN IEC 60093)	[Ω]	10 <sup>6</sup>		10 <sup>13</sup>	10 <sup>14</sup>	10 <sup>12</sup>	10 <sup>14</sup>	10 <sup>14</sup>	10 <sup>14</sup>	10 <sup>14</sup>	10 <sup>14</sup>
<b>Miscellaneous data</b>											
Water absorption 24h / 96h (23 °C) (DIN EN ISO 62)	[%]	0.02 / 0.03	0.02 / 0.03	0.02 / 0.03	0.02 / 0.03	0.02 / 0.03	0.02 / 0.03	0.02 / 0.03	0.02 / 0.03	0.02 / 0.03	0.02 / 0.03
Resistance to hot water / bases		+	+	+	+	+	+	+	+	+	+
Resistance to weathering		(+)	-	-	-	-	-	-	-	-	-
Flammability (UL94) (DIN IEC 60695-11-10:)		V0	V0	V0	V0	V0	V0	V0	V0	V0	V0

Data generated directly after machining (standard climate Germany). For polyamides the values strongly depend on the humidity content.



Test specimen to DIN EN ISO 527-2

+ good resistance  
 (+) limited resistance  
 - poor resistance (depending on concentration, time and temperature)  
 n.b. not broken  
 n.a. not applicable

(a) Glass transition temperature testing according to DIN EN ISO 11357  
 (b) Thermal conductivity testing according to ISO 8302  
 (c) Thermal conductivity testing according to ASTM E1530  
 (d) Surface resistance testing according to ASTM D 257



Material		TECAPEEK CF30 MT	TECAPEEK CLASSIX white	TECAPEEK TS	TECAPEEK CMF	TECAPEEK CMF grey	TECAPEEK HT black	TECAPEEK ST black	TECATEC PEEK CW50	TECATEC PEKK CW60	TECATOR 5013
Chemical Designation		PEEK	PEEK	PEEK	PEEK	PEEK	PEK	PEKEKK	PEEK	PEKK	PAI
Fillers		carbon fibres		mineral filler	ceramic	ceramic					
Density (DIN EN ISO 1183)	[g / cm <sup>3</sup> ]	1.42	1.4	1.49	1.65	1.65	1.31	1.32	1.49	1.61	1.4
<b>Mechanical properties</b>											
Modulus of elasticity (tensile test) (DIN EN ISO 527-2)	[MPa]	6,000	4,700	5,700	5,500	5,500	4,600	4,600	53,200	54,300	3,800
Tensile strength (DIN EN ISO 527-2)	[MPa]	115	117	110	105	105	120	134	491	585	151
Tensile strength at yield (DIN EN ISO 527-2)	[MPa]	115	117	110	102	102	120	134			151
Elongation at yield (DIN EN ISO 527-2)	[%]	5	5	4	3	4	4	5			
Elongation at break (DIN EN ISO 527-2)	[%]	5	11	4	4	5	5	13			21
Modulus of elasticity (flexural test) (DIN EN ISO 178)	[MPa]	6,000	4,400	5,900	5,500	5,500	4,600	4,600	48,900	50,900	3,900
Flexural strength (DIN EN ISO 178)	[MPa]	188	177	175	170	170	192	193	813	960	
Compression modulus (EN ISO 604)	[MPa]	4,500	3,500	4,300	4,300	4,300	3,500	3,500	4,050	5,100	
Compressive strength (1% / 2%) (EN ISO 604)	[MPa]	23 / 44	25 / 45	17 / 34	25 / 46	25 / 46	25 / 45	24 / 42		51 / 509	
Impact strength (Charpy) (DIN EN ISO 179-1eU)	[kJ / m <sup>2</sup> ]	58	n.b.	n.b.	65	35	n.b.	n.b.			
Notched impact strength (Charpy) (DIN EN ISO 179-1eA)	[kJ / m <sup>2</sup> ]		5	7			4	4			13.2
Ball indentation hardness (ISO 2039-1)	[MPa]	318	263	290	286	286	282	275			240
<b>Thermal properties</b>											
Glass transition temperature (DIN 53765)	[°C]	146	150	151	151	151	160	165	143	165	280
Melting temperature (DIN 53765)	[°C]	341	341	339	339	339	375	384	343	380	n.a.
Service temperature, short term	[°C]	300	300	300	300	300	300	300			270
Service temperature, long term	[°C]	260	260	260	260	260	260	260	260	260	250
Thermal expansion (CLTE), 23 – 60 °C (DIN EN ISO 11359-1;2)	[10 <sup>-5</sup> K <sup>-1</sup> ]	5	5	4	5	5	5	5			
Thermal expansion (CLTE), 23 – 100 °C (DIN EN ISO 11359-1;2)	[10 <sup>-5</sup> K <sup>-1</sup> ]	5	5	4	5	5	5	5			
Specific heat (ISO 22007-4:2008)	[J / (g*K)]	1.7	1.0		1.0	1.0					
Thermal conductivity (ISO 22007-4:2008)	[W / (m*K)]	0.59	0.30		0.38	0.38					0.29 (c)
<b>Electrical properties</b>											
Surface resistance (DIN IEC 60093)	[Ω]	10 <sup>8</sup>	10 <sup>14</sup>	10 <sup>13</sup>	10 <sup>14</sup>	10 <sup>13</sup>	10 <sup>9</sup>	10 <sup>9</sup>			10 <sup>18</sup> (d)
<b>Miscellaneous data</b>											
Water absorption 24h / 96h (23 °C) (DIN EN ISO 62)	[%]	0.02 / 0.03	0.02 / 0.03	0.02 / 0.03	0.02 / 0.03	0.02 / 0.03	0.02 / 0.04	0.02 / 0.03			
Resistance to hot water / bases		+	+	+	+	+	+	+	+	+	-
Resistance to weathering		-	-	-	-	-	(+)	(+)	-	-	
Flammability (UL94) (DIN IEC 60695-11-10:)		V0	V0	V0	V0	V0	V0	V0	V0	V0	V0

The corresponding values and information are no minimum or maximum values, but guideline values that can be used primarily for comparison purposes for material selection. These values are within the normal tolerance range of product properties and do not represent guaranteed property values. Therefore they shall not be used for specification purposes. Unless otherwise noted, these values were

determined by tests at reference dimensions (typically rods with diameter 40-60 mm according to DIN EN 15860) on extruded, cast, compression moulded and machined specimens. As the properties depend on the dimensions of the semi-finished products and the orientation in the component (esp. in reinforced grades), the material may not be used without separate testing under individual circumstances.

Data sheet values are subject to periodic review, the most recent update can be found at [www.ensinger-online.com](http://www.ensinger-online.com)

Technical changes reserved.

# Material standard values

Material		TECATOR 5031 PVX	TECASINT 1011	TECASINT 1021	TECASINT 1031	TECASINT 1041	TECASINT 1061	TECASINT 1101	TECASINT 1611	TECASINT 2011	TECASINT 2021
Chemical Designation		PAI	PI	PI	PI	PI	PI	PI	PI	PI	PI
Fillers		graphite, PTFE		15% graphite	40% graphite	30% molyb- denum disulfide	15% graphite, 10% PTFE		30% PTFE		15% graphite
Density (DIN EN ISO 1183)	[g / cm <sup>3</sup> ]	1.46	1.34	1.42	1.57	1.67	1.48	1.34	1.51	1.38	1.45
<b>Mechanical properties</b>											
Modulus of elasticity (tensile test) (DIN EN ISO 527-2)	[MPa]	5,900	4,000	4,000		4,340		4,000		3,700	4,400
Tensile strength (DIN EN ISO 527-2)	[MPa]	135	116	97	65	82	77	153	82	118	101
Tensile strength at yield (DIN EN ISO 527-2)	[MPa]	135									
Elongation at yield (DIN EN ISO 527-2)	[%]										
Elongation at break (DIN EN ISO 527-2)	[%]	7	9.0	2.8	2.2	2.8	2.9	7.4	4.1	4.5	3.7
Modulus of elasticity (flexural test) (DIN EN ISO 178)	[MPa]	6,200	3,448	4,000		4,330		4,000		3,600	4,300
Flexural strength (DIN EN ISO 178)	[MPa]		210	150	88	126	120	209	122	177	145
Compression modulus (EN ISO 604)	[MPa]		4,000	1,880				4,000		1,713	1,900
Compressive strength (1% / 2%) (EN ISO 604)	[MPa]		556	210	180	204	227	400	211	486	300
Impact strength (Charpy) (DIN EN ISO 179-1eU)	[kJ / m <sup>2</sup> ]	87	75.8	35.1	16.5	29.6	25.8	67.6	-	87.9	20.6
Notched impact strength (Charpy) (DIN EN ISO 179-1eA)	[kJ / m <sup>2</sup> ]	5.6	3.3	4.8	3.6	2.8	3.9	-	-	9.3	1.6
Ball indentation hardness (ISO 2039-1)	[MPa]	228									
<b>Thermal properties</b>											
Glass transition temperature (DIN 53765)	[°C]	280	368 (a)	330 (a)	330 (a)	330 (a)	330 (a)	330 (a)	330 (a)	370 (a)	370 (a)
Melting temperature (DIN 53765)	[°C]	n.a.									
Service temperature, short term	[°C]	270									
Service temperature, long term	[°C]	250	-	-	-	-	-	-	-	-	-
Thermal expansion (CLTE), 23 – 60 °C (DIN EN ISO 11359-1;2)	[10 <sup>-5</sup> K <sup>-1</sup> ]										
Thermal expansion (CLTE), 23 – 100 °C (DIN EN ISO 11359-1;2)	[10 <sup>-5</sup> K <sup>-1</sup> ]										
Specific heat (ISO 22007-4:2008)	[J / (g*K)]		1.04	1.13				1.04		0.925	
Thermal conductivity (ISO 22007-4:2008)	[W / (m*K)]	0.60 (c)	0.22 (b)	0.53 (b)				0.22 (b)		0.22 (b)	
<b>Electrical properties</b>											
Surface resistance (DIN IEC 60093)	[Ω]	10 <sup>17</sup> (d)	10 <sup>16</sup>	10 <sup>7</sup>	10 <sup>3</sup>			10 <sup>15</sup>	10 <sup>16</sup>	10 <sup>15</sup>	
<b>Miscellaneous data</b>											
Water absorption 24h / 96h (23 °C) (DIN EN ISO 62)	[%]										
Resistance to hot water / bases		-									
Resistance to weathering											
Flammability (UL94) (DIN IEC 60695-11-10:)		V0	V0	V0	V0	V0	V0	V0	V0	V0	V0

Data generated directly after machining (standard climate Germany). For polyamides the values strongly depend on the humidity content.

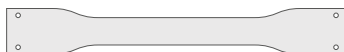

Test specimen to DIN EN ISO 527-2

- + good resistance
- (+) limited resistance
- poor resistance (depending on concentration, time and temperature)
- n.b. not broken
- n.a. not applicable

- (a) Glass transition temperature testing according to DIN EN ISO 11357
- (b) Thermal conductivity testing according to ISO 8302
- (c) Thermal conductivity testing according to ASTM E1530
- (d) Surface resistance testing according to ASTM D 257

Material		TECASINT 2031	TECASINT 2391	TECASINT 4011	TECASINT 4021	TECASINT 4111	TECASINT 4121	TECASINT 5051	TECASINT 5201 SD	TECASINT 8001
Chemical Designation		PI	PI	PI	PI	PI	PI	PAI	PAI	PTFE
Fillers		40% graphite	15% molyb- denum disulfide		15% graphite		15% graphite	30% glass fibres	carbon fibres, glass fibres	20% polyimide
Density (DIN EN ISO 1183)	[g / cm <sup>3</sup> ]	1.59	1.54	1.41	1.49	1.46	1.53	1.57	1.54	1.88
<b>Mechanical properties</b>										
Modulus of elasticity (tensile test) (DIN EN ISO 527-2)	[MPa]	6,300	4,400	4,000	4,943	7,000	6,600	5,800	4,500	
Tensile strength (DIN EN ISO 527-2)	[MPa]	65	95	130	93	100	34	94	85	15
Tensile strength at yield (DIN EN ISO 527-2)	[MPa]									
Elongation at yield (DIN EN ISO 527-2)	[%]									
Elongation at break (DIN EN ISO 527-2)	[%]	2.1	2.9	4.5	3	1.7	0.5	3.4	4.0	200
Modulus of elasticity (flexural test) (DIN EN ISO 178)	[MPa]	5,200	4,136	4,300	4,930	6,100	6,100	6,625	4,200	
Flexural strength (DIN EN ISO 178)	[MPa]	87.5	137	180	131	160	113	163	135	
Compression modulus (EN ISO 604)	[MPa]	2,027	2,200	2,100	2,067	2,500	2,200	2,590		
Compressive strength (1% / 2%) (EN ISO 604)	[MPa]	131	253	40	208	250	200	260	240	
Impact strength (Charpy) (DIN EN ISO 179-1eU)	[kJ / m <sup>2</sup> ]	14.2		87	24.4	24	11	27.3	17.8	
Notched impact strength (Charpy) (DIN EN ISO 179-1eA)	[kJ / m <sup>2</sup> ]	3.3		9.6	4.8	1.1	1.4	5.1	2.8	
Ball indentation hardness (ISO 2039-1)	[MPa]									
<b>Thermal properties</b>										
Glass transition temperature (DIN 53765)	[°C]	370 (a)	370 (a)	260 (a)	260 (a)	n.a. (a)	n.a. (a)	340 (a)	340 (a)	20 (a)
Melting temperature (DIN 53765)	[°C]									
Service temperature, short term	[°C]									
Service temperature, long term	[°C]	-	-					300	300	250
Thermal expansion (CLTE), 23 – 60 °C (DIN EN ISO 11359-1;2)	[10 <sup>-5</sup> K <sup>-1</sup> ]									
Thermal expansion (CLTE), 23 – 100 °C (DIN EN ISO 11359-1;2)	[10 <sup>-5</sup> K <sup>-1</sup> ]									
Specific heat (ISO 22007-4:2008)	[J / (g*K)]			1.04						1
Thermal conductivity (ISO 22007-4:2008)	[W / (m*K)]			0.4 (b)		0.35 (b)				0.25 (b)
<b>Electrical properties</b>										
Surface resistance (DIN IEC 60093)	[Ω]			10 <sup>15</sup> (d)		10 <sup>15</sup> (d)		10 <sup>14</sup>	10 <sup>11</sup>	
<b>Miscellaneous data</b>										
Water absorption 24h / 96h (23 °C) (DIN EN ISO 62)	[%]									
Resistance to hot water / bases										
Resistance to weathering										
Flammability (UL94) (DIN IEC 60695-11-10:)		V0	V0	V0	V0	V0	V0	V0	V0	V0

The corresponding values and information are no minimum or maximum values, but guideline values that can be used primarily for comparison purposes for material selection. These values are within the normal tolerance range of product properties and do not represent guaranteed property values. Therefore they shall not be used for specification purposes. Unless otherwise noted, these values were

determined by tests at reference dimensions (typically rods with diameter 40-60 mm according to DIN EN 15860) on extruded, cast, compression moulded and machined specimens. As the properties depend on the dimensions of the semi-finished products and the orientation in the component (esp. in reinforced grades), the material may not be used without separate testing under individual circumstances.

Data sheet values are subject to periodic review, the most recent update can be found at [www.ensinger-online.com](http://www.ensinger-online.com)

Technical changes reserved.

## Liability disclaimer

Our information and statements do not constitute a promise or guarantee whether these are express or inferred. This information is provided to the best of our current knowledge and is designed to provide data about our products and their applications. They are consequently not intended to provide any legally binding guarantee or assurance of chemical resistance, product properties or saleability.

The suitability for the end use of the products is influenced by various factors such as choice of materials, additions to the material, design of shaped parts and tools, and processing or environmental conditions. Unless otherwise indicated, the measured values are guideline values which are based on laboratory tests under standardized conditions. The information provided does not, alone, form any sufficient basis for component or tool design. The decision as to the suitability of a particular material or procedure or a particular component and tool design for a specific purpose is left exclusively to the customer in question. Suitability for a specific purpose or a particular use is not assured or guaranteed on a legally binding basis, unless we have been informed in writing about the specific purpose and conditions of use and we have confirmed in writing that our product is specifically suitable for the application or for the planned use described in writing.

The nature of our products conforms to statutory provisions valid in Germany at the time of the transfer of risk, in so far as these statutory provisions contain regulations regarding the nature of these products specifically. Only if the customer points out expressly in writing that he intends to export our products – also after processing or installation if applicable – and only if we expressly confirm the suitability of the goods for export, shall we also ensure compliance with the export regulations of the European Union, its member states, the other states who are signatory to the agreement on the European Economic Area (Norway, Iceland, Liechtenstein) and Switzerland and the USA. We are not obliged to take any steps to comply with the statutory regulations of other states.

We are responsible for ensuring that our products are free from any rights or claims by third parties based on commercial or other intellectual property (patents, patented designs, registered designs, authors' rights and other rights). This obligation applies for Germany; it only applies for the other member states of the European Union and the other states who are signatory to the agreement on the European Economic Area and Switzerland and the USA if the customer expressly points out to us in writing that he intends to export our products – after processing or installation if applicable - and we expressly confirm in writing that the products can be exported. We shall not accept liability for any other states than those listed.

We reserve the right to make changes to the design or form, deviations in colour and changes to the scope of delivery or service in so far as the changes or deviations are reasonable for the customer whilst taking our interests into account.

Our products are not intended for use in medical or dental implants.

PEEK-CLASSIX™ and Invibio® are registered trademarks of Invibio Ltd.

VICTREX® PEEK is a registered trademark of Victrex plc.

Ensinger®, TECA®, TECADUR®, TECAFLON®, TECAFORM®, TECAM®, TECAMID®, TECANAT®, TECANYL®, TECAPEEK®, TECAPET®, TECAPRO®, TECASINT®, TECASON®, TECAST®, TECATRON® are registered trademarks of Ensinger GmbH.

TECATOR® is a registered trademark of Ensinger Inc.

**Ensinger: Facts and figures**

**Headquarter**

Nufringen, Germany

**Workforce**

appr. 2000

**Year of formation**

1966

**Producing locations  
in Germany**

3

**Locations and  
branches worldwide**

27

**Directors**

Klaus Ensinger, Dr. Roland Reber

**Products**

- Compounds
- Stock shapes  
(extruded, cast, sintered)
- Profiles
- Finished parts  
(machined, injection moulded)
- Custom castings  
(direct formed, cast polyamide)

**Applications**

- Mechanical and plant engineering
- Construction industry
- Automotive engineering
- Medical technology
- Aerospace industry
- Oil and gas industry
- Electrical and semiconductor  
engineering
- Many other branches of industry

### **Ensinger Germany**

Ensinger GmbH  
Rudolf-Diesel-Straße 8  
71154 Nufringen  
Tel. +49 7032 819 0  
Fax +49 7032 819 100  
www.ensinger-online.com

Ensinger GmbH  
Mercedesstraße 21  
72108 Rottenburg a. N.  
Tel. +49 7457 9467 100  
Fax +49 7457 9467 122  
www.ensinger-online.com

Ensinger GmbH  
Wilfried-Ensinger-Straße 1  
93413 Cham  
Tel. +49 9971 396 0  
Fax +49 9971 396 570  
www.ensinger-online.com

Ensinger GmbH  
Borsigstraße 7  
59609 Anröchte  
Tel. +49 2947 9722 0  
Fax +49 2947 9722 77  
www.ensinger-online.com

Ensinger GmbH  
Mooswiesen 13  
88214 Ravensburg  
Tel. +49 751 35452 0  
Fax +49 751 35452 22  
www.thermix.de

### **Ensinger worldwide**

**Austria**  
Ensinger Sintimid GmbH  
Werkstraße 3  
4860 Lenzing  
Tel. +43 7672 7012800  
Fax +43 7672 96865  
www.ensinger-sintimid.at

**Brazil**  
Ensinger Indústria de  
Plásticos Técnicos Ltda.  
Av. São Borja 3185  
93.032-000 São Leopoldo-RS  
Tel. +55 51 35798800  
Fax +55 51 35882804  
www.ensinger.com.br

**China**  
Ensinger (China) Co., Ltd.  
1F, Building A3  
No. 1528 Gumei Road  
Shanghai 200233  
P.R.China  
Tel. +86 21 52285111  
Fax +86 21 52285222  
www.ensinger-china.com

**Czech Republic**  
Ensinger s.r.o.  
Průmyslová 991  
P.O. Box 15  
33441 Dobřany  
Tel. +420 37 7972056  
Fax +420 37 7972059  
www.ensinger.cz

**Denmark**  
Ensinger Danmark  
Rugvænget 6  
4100 Ringsted  
Tel. +45 7810 4410  
Fax +45 7810 4420  
www.ensinger.dk

**France**  
Ensinger France S.A.R.L.  
ZAC les Batterses  
ZI Nord  
01700 Beynost  
Tel. +33 4 78553635  
Fax +33 4 78556841  
www.ensinger.fr

**Italy**  
Ensinger Italia S.r.l.  
Via Franco Tosi 1/3  
20020 Olcella di Busto  
Garolfo  
Tel. +39 0331 568348  
Fax +39 0331 567822  
www.ensinger.it

**Japan**  
Ensinger Japan Co., Ltd.  
3-5-1, Rinkaicho,  
Edogawa-ku, Tokyo  
134-0086, Japan  
Tel. +81 3 5878 1903  
Fax +81 3 5878 1904  
www.ensinger.jp

**Poland**  
Ensinger Polska Sp. z o.o.  
ul. Spółdzielcza 2h  
64-100 Leszno  
Tel. +48 65 5295810  
Fax +48 65 5295811  
www.ensinger.pl

**Singapur**  
Ensinger International GmbH  
(Singapore Branch)  
63 Hillview Avenue # 04-07  
Lam Soon Industrial Building  
Singapore 669569  
Tel. +65 65524177  
Fax +65 65525177  
info@ensinger.com.sg

**Spain**  
Ensinger S.A.  
Girona, 21-27  
08120 La Llagosta  
Barcelona  
Tel. +34 93 5745726  
Fax +34 93 5742730  
www.ensinger.es

**Sweden**  
Ensinger Sweden AB  
Stenvretsgatan 5  
SE-749 40 Enköping  
Tel. +46 171 477 050  
Fax +46 171 440 418  
www.ensinger.se

**United Kingdom**  
Ensinger Limited  
Wilfried Way  
Tonyrefail  
Mid Glamorgan CF39 8JQ  
Tel. +44 1443 678400  
Fax +44 1443 675777  
www.ensinger.co.uk

**USA**  
Ensinger Inc.  
365 Meadowlands Boulevard  
Washington, PA 15301  
Tel. +1 724 746 6050  
Fax +1 724 746 9209  
www.ensinger-inc.com

*Thermoplastic engineering and high-performance plastics from Ensinger are used in almost every important sector of industry today. Their economy and performance benefits have seen them frequently supplant classically used materials.*

